



MAXILARIA



Instrumental quirúrgico
CIRUGÍA CRÁNEO-MAXILOFACIAL



MAXILARIA

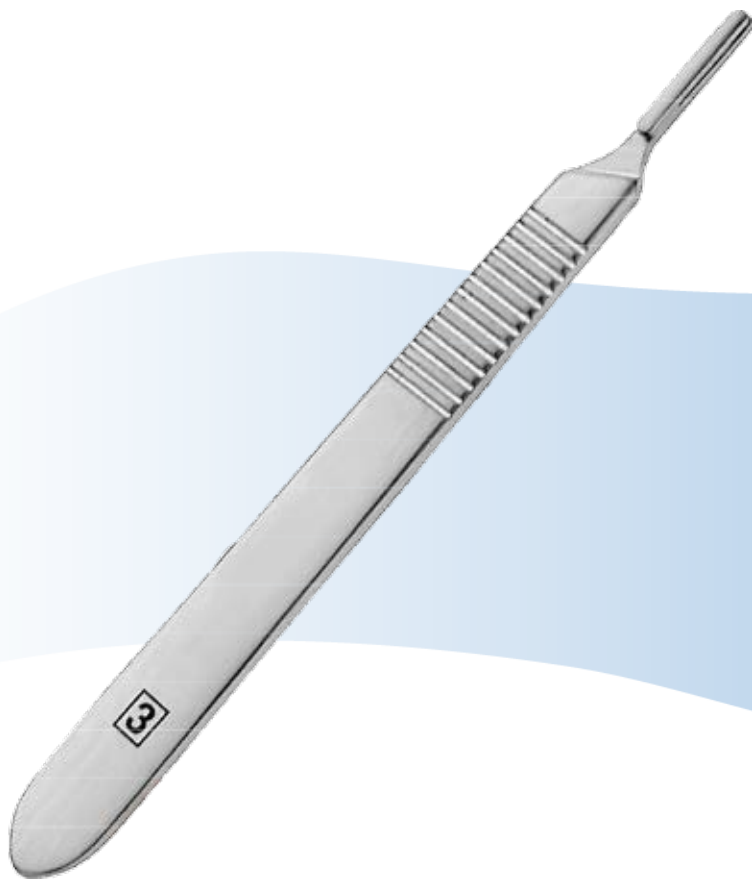

Bisturís

paquete de 100 unidades, estéril



06.110.00
Fig. 10



06.111.00
Fig. 11



06.112.00
Fig. 12



06.112.02
Fig. 12 d



06.115.00
Fig. 15



06.115.01
Fig. 15 c



06.103.00
12 cm/4¾"
Fig. 3

redondo



06.103.03
14,5 cm/5¾"
Fig. 3 R

redondo, angulado



06.103.33
14 cm/5½"
Fig. 3 R

con mango hueco redondo



06.103.09
15,5 cm/6"
Fig. 3

largo



06.107.00
16 cm/6¼"
Fig. 7

en paquetes de 10 unidades, estéril



06.304.15
15,5 cm/6"



40.859.01
Fig. 61



40.859.02
Fig. 62



40.859.04
Fig. 64



40.859.05
Fig. 65



40.859.07
Fig. 67



40.859.09
Fig. 69



MAXILARIA

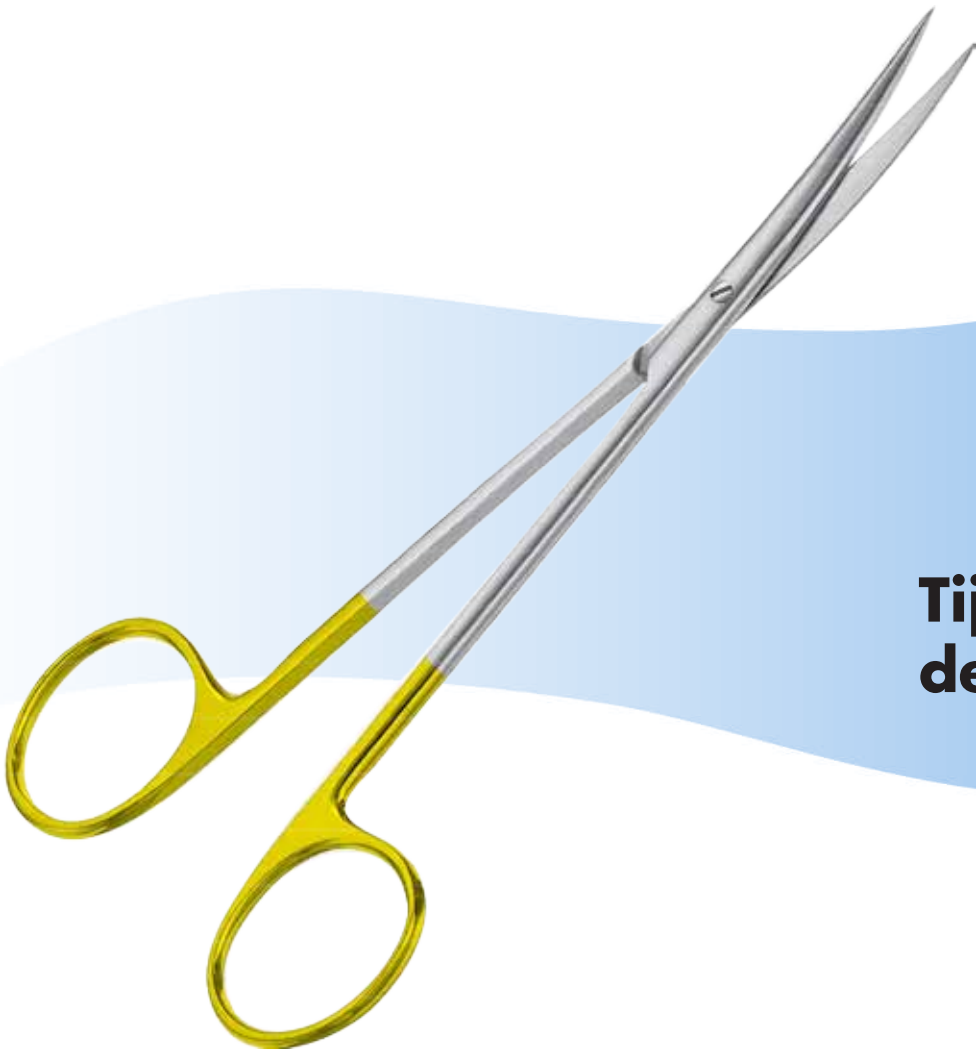

**Tijeras
de disección**



Cuchilla de Carburo de Tungsteno

MAYO

4,5 cm/5 ³ / ₄ "	08.164.14	08.165.14
7 cm/6 ³ / ₄ "	08.164.17	08.165.17
3 cm/9"	08.164.23	08.165.23

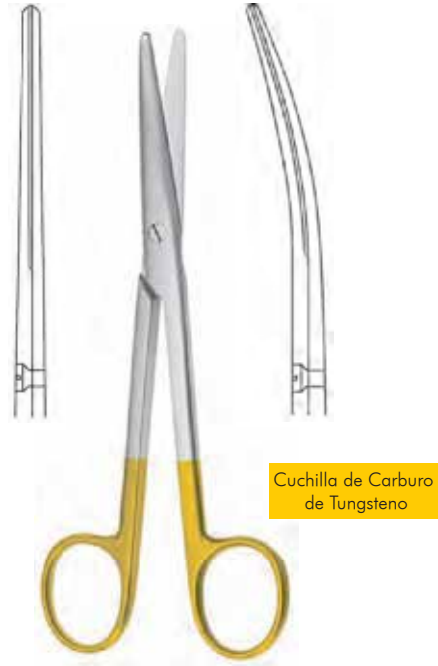

Cuchilla de Carburo de Tungsteno

MAYO-STILLE

15 cm/6"	08.174.15	08.175.15
17 cm/6 ³ / ₄ "	08.174.17	08.175.17



Cuchilla de Carburo de Tungsteno

LEXER

6 cm/6 ¹ / ₄ "	08.194.16	08.195.16
--------------------------------------	------------------	------------------

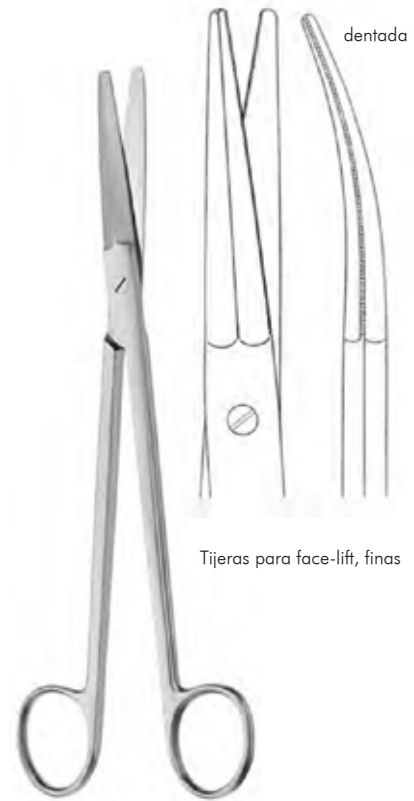

dentada

Tijeras para face-lift, finas

GORNEY
08.213.19
19,5 cm/7³/₄"



Cuchilla de Carburo de Tungsteno



Cuchilla de Carburo de Tungsteno

METZENBAUM		
15 cm/6"	08.284.15	08.285.15
18 cm/7"	08.284.18	08.285.18
20 cm/8"	08.284.20	08.285.20
23 cm/9"	08.284.23	08.285.23

METZENBAUM FINO		
15 cm/6"	08.286.15	08.287.15
18 cm/7"	08.286.18	08.287.18
20 cm/8"	08.286.20	08.287.20
23 cm/9"	08.286.23	08.287.23



08.297.14
14,5 cm/5¾"

08.297.18
18 cm/7"

Cuchilla de Carburo
de Tungsteno

METZENBAUM FINO

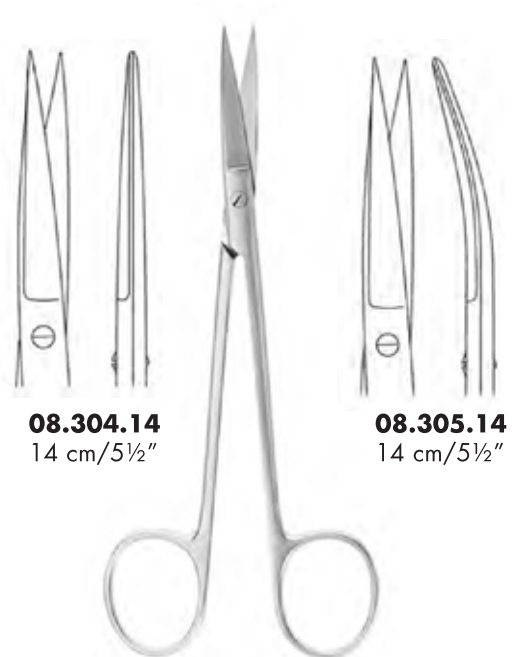

08.304.14
14 cm/5½"

08.305.14
14 cm/5½"

JOSEPH



Cuchilla de Carburo
de Tungsteno

KILNER

12 cm/4¾" **08.314.12**
15 cm/6" **08.314.15**



Cuchilla de Carburo
de Tungsteno

LOCKLIN

08.316.16
16 cm/6¼"

un filo dentado

Cuchilla de Carburo
de Tungsteno



IRIS
08.340.11
11,5 cm/4½"



IRIS
08.341.11
11,5 cm/4½"



IRIS
08.344.11
11,5 cm/4½"



IRIS
08.345.11
11,5 cm/4½"



KELLY
16 cm/6¼"

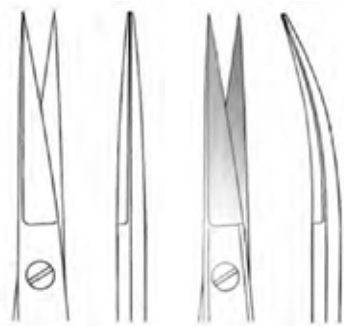

08.540.16

08.541.16



Tijeras para Rinoplastia

FOMON
08.403.14
14 cm/5½"

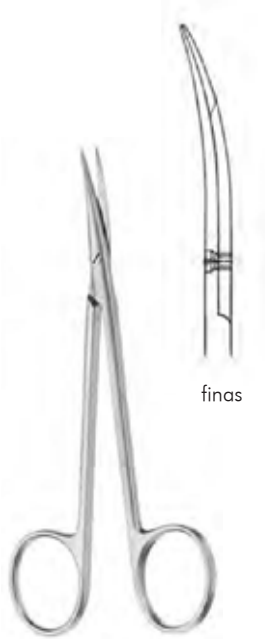

finas

JAMESON-WERBER
08.584.13
13 cm/5"



08.584.15
15 cm/6"

finas

JAMESON

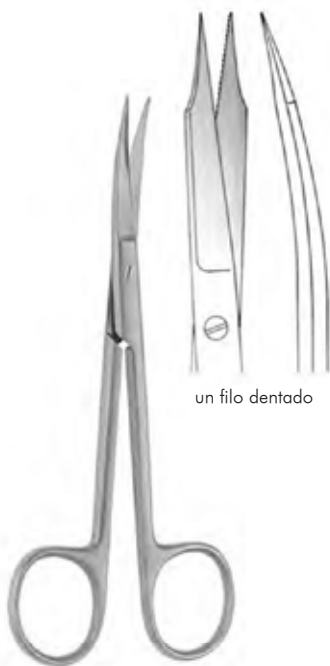

un filo dentado

GOLDMAN FOX
08.821.13
13 cm/5"



un filo dentado

Cuchilla de Carburo
de Tungsteno

GOLDMAN FOX
08.823.13
13 cm/5"

Mango ligero y redondeado, equilibrado



15 cm/5"	09.300.15	09.301.15
18 cm/7"	09.300.18	09.301.18



SUPERCUT

18 cm/7"	09.302.18
09.303.18	



dentadas

15 cm/5"	09.304.15	09.305.15
18 cm/7"	09.304.18	09.305.18



hoja redondeada

15 cm/5"	09.307.15	09.309.15
18 cm/7"	09.307.18	09.309.18



MAXILARIA

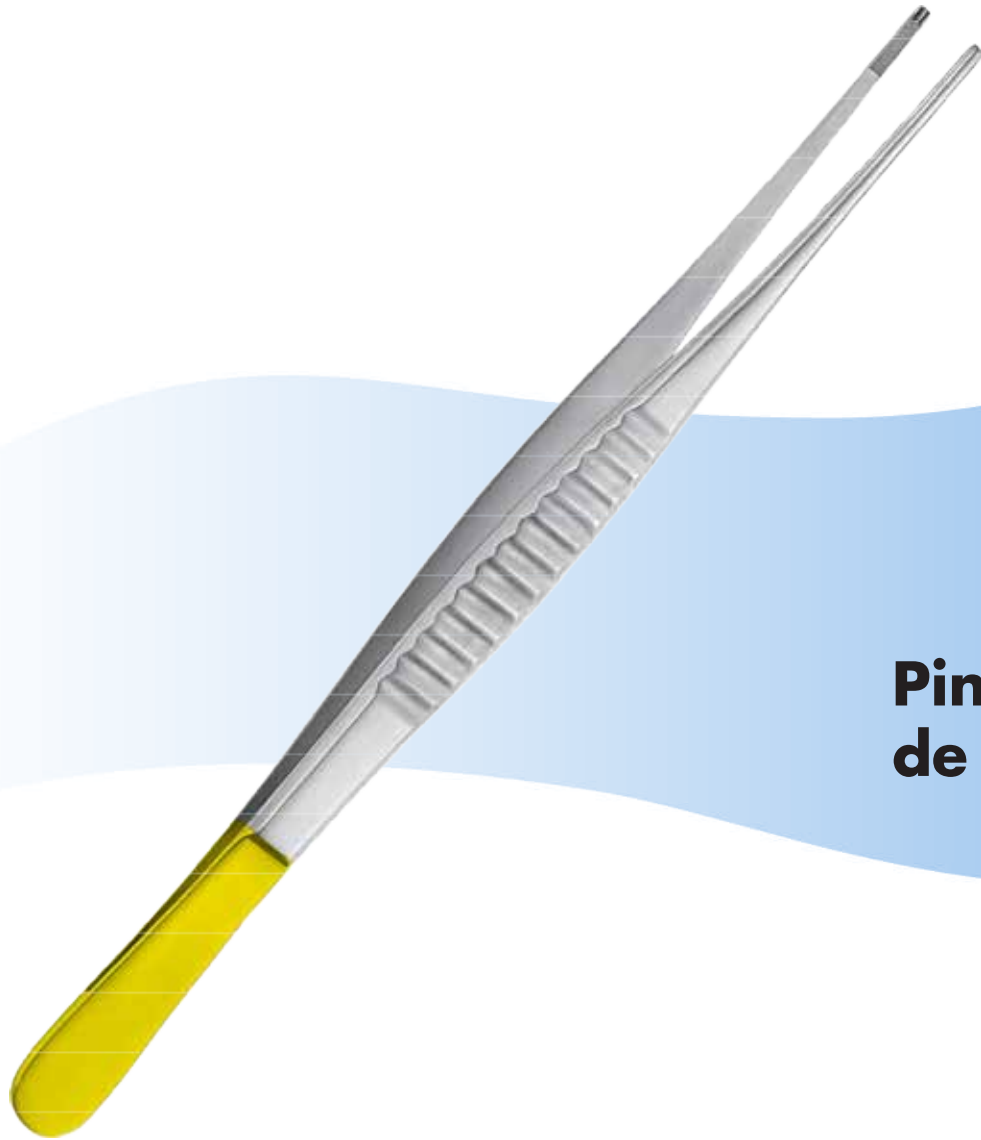

**Pinzas
de disección**



Revestimiento de Carburo de Tungsteno

ADSON
12 cm/4¾" **10.184.12**
15 cm/6" **10.184.15**

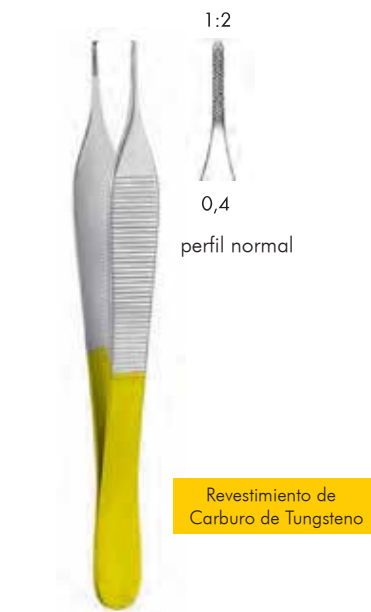

Revestimiento de Carburo de Tungsteno

ADSON micro
12 cm/4¾" **10.173.12**
15 cm/6" **10.173.15**



CUSHING
17 cm/6¾"



finas

SEMKEN

10.268.12 12,5 cm/5"
10.268.14 14,5 cm/5¾"



SEMKEN

10.270.12 12,5 cm/5"
10.270.15 15 cm/6"



Revestimiento de Carburo de Tungsteno

GILLIES
10.272.16
15,5 cm/6"



10.332.01
12 cm/4¾"
Fig. 1



10.330.12
12 cm/4¾"
Fig. 3

finas



10.330.31
11 cm/4¼"
Fig. 3 C



10.332.04
11 cm/4¼"
Fig. 4



10.332.05
11 cm/4¼"
Fig. 5



10.332.45
11 cm/4¼"
Fig. 5

0,3 mm
45°



10.333.05
11 cm/4¼"
Fig. 5a



10.332.15
11 cm/4¼"
Fig. 6



10.331.12
12 cm/4¾"
Fig. 7



10.333.11
11,5 cm/4½"

1:2

Mango ligero y redondeado, equilibrado

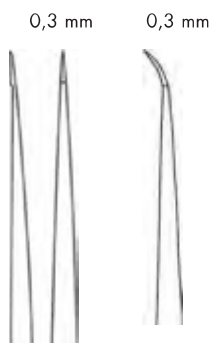

11.110.15 15 cm/6"
11.111.15 15 cm/6"

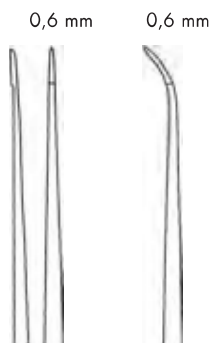

11.110.18 18 cm/7"
11.111.18 18 cm/7"

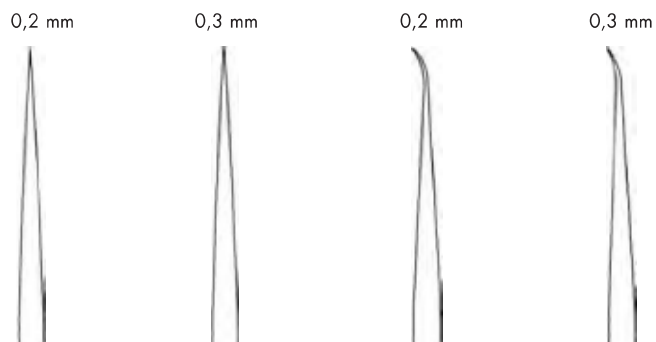

11.218.15 15 cm/6" afilada
11.220.15 15 cm/6" roma
11.219.15 15 cm/6" afilada
11.221.15 15 cm/6" roma

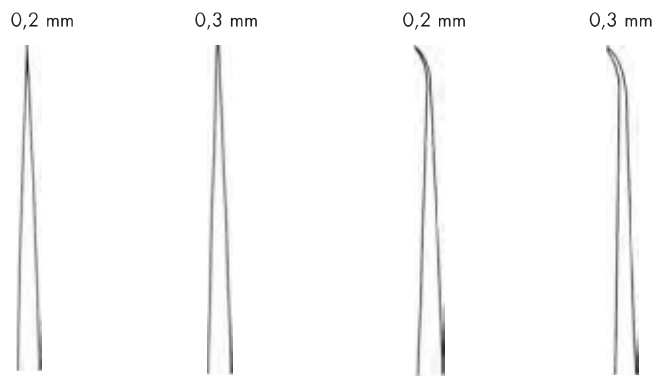

11.218.18 18 cm/7" afilada
11.220.18 18 cm/7" roma
11.219.18 18 cm/7" afilada
11.221.18 18 cm/7" roma

ATRAUMA



DE BAKEY



DE BAKEY

Revestimiento de Carburo de Tungsteno

1,5 mm	2,0 mm	2,7 mm	3,5 mm
6 x 12	6 x 12	6 x 12	6 x 12



15 cm/6"	11.404.15	11.412.15	11.414.15	11.416.15
19,5 cm/7¾"	11.404.19	11.412.19	11.414.19	11.416.19
24 cm/9½"	11.404.24	11.412.24	11.414.24	11.416.24

1,5 mm	2,0 mm	2,7 mm	3,5 mm
2 x 4	2 x 4	2 x 4	2 x 4



15 cm/6"	11.402.15	11.422.15	11.424.15	11.426.15
19,5 cm/7¾"	11.402.20	11.422.19	11.424.19	11.426.19
24 cm/9½"	11.402.24	11.422.24	11.424.24	11.426.24



MAXILARIA

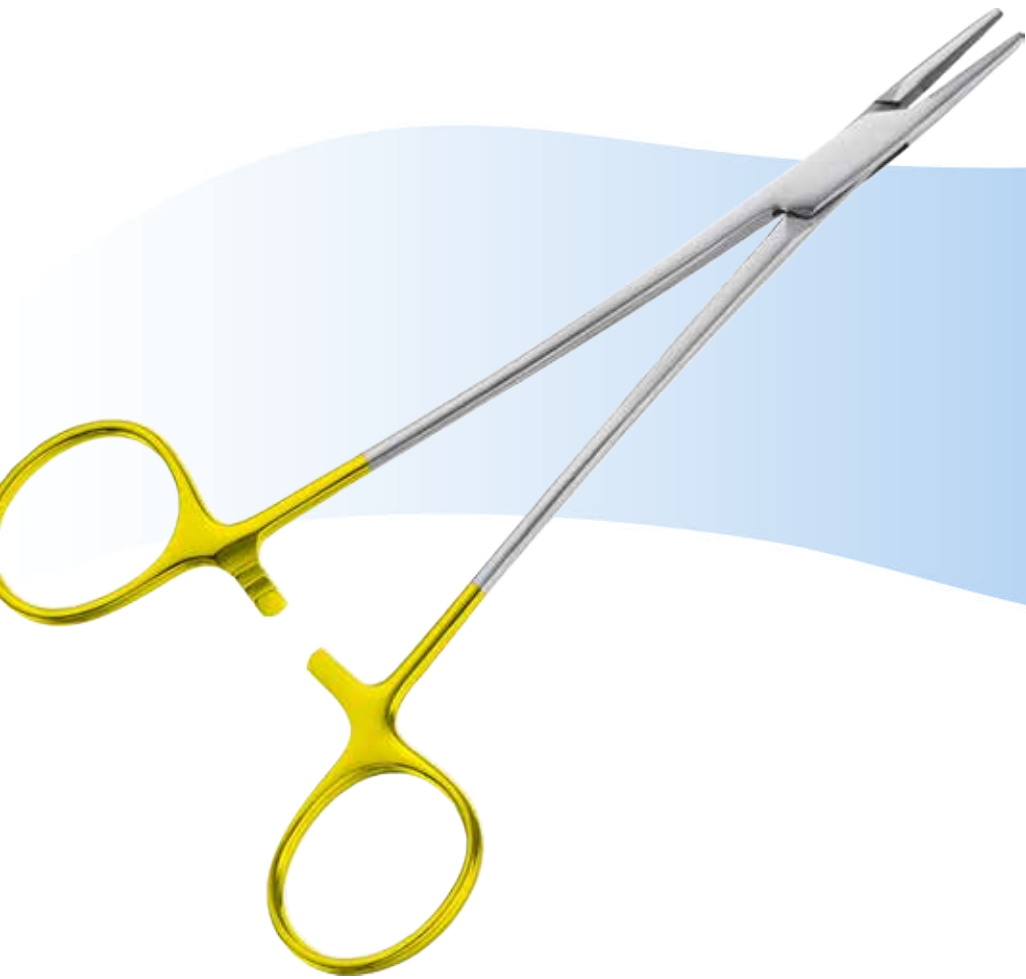

Sutura

Revestimiento de
Carburo de Tungsteno



24.134.13

boca lisa

24.144.13

0,4
perfil mini

HALSEY
13 cm/5¹/₈"



24.147.13

0,4
perfil mini

NEIVERT
13 cm/5¹/₈"



0,5
perfil estándar

BAUMGARTNER
12,5 cm/5" **24.154.12**
14 cm/5¹/₂" **24.154.14**



0,5

perfil estándar

NEW ORLEANS
24.144.18
18 cm/7"



0,4
perfil mini

CRILE WOOD

24.164.15
15 cm/6"

24.164.18
18 cm/7"

24.164.20
20 cm/7³/₄"







0,4
perfil mini

BABY CRILE WOOD
24.168.15
15 cm/6"





Revestimiento de Carburo de Tungsteno



- | | | | |
|---|---|---|---|
|  |  |  |  |
| 24.184.14
14 cm/5½" | 24.184.16
16 cm/6¼" | 24.184.18
18 cm/7" | 24.184.20
20 cm/8" |
|  |  |  | |
| 24.184.24
24 cm/9½" | 24.184.26
26 cm/10¼" | 24.184.30
30 cm/12" | |
|  |  | boca lisa | |
| 24.186.16
16 cm/6¼" | 24.186.18
18 cm/7" | | |

0,5
perfil estándar



- | | | | |
|---|---|---|---|
|  |  |  |  |
| 24.216.16
16 cm/6¼" | 24.216.18
18 cm/7" | 24.216.21
21 cm/8¼" | 24.216.23
23 cm/9" |

0,2
perfil micro

modelo delgado



0,4
perfil mini

modelo delgado

- | |
|--------------------------------|
| 24.216.31
31 cm/12½" |
|--------------------------------|

Revestimiento de
Carburo de Tungsteno



CASTROVIEJO-
JACOBSON

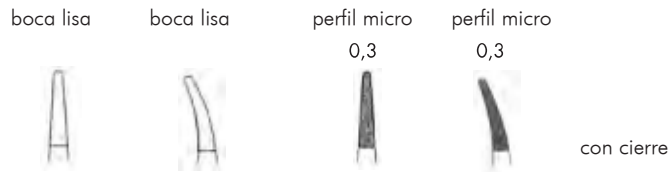

14,5 cm/5¾"	24.674.14	24.675.14	24.678.14	24.679.14
18 cm/7"	24.674.18	24.675.18	24.678.18	24.679.18
21 cm/8¼"	24.674.21	24.675.21	24.678.21	24.679.21
23 cm/9"	24.674.23	24.675.23	24.678.23	24.679.23



14,5 cm/5¾"	24.694.14	24.695.14	24.698.14	24.699.14
18 cm/7"	24.694.18	24.695.18	24.698.18	24.699.18
21 cm/8¼"	24.694.21	24.695.21	24.698.21	24.699.21
23 cm/9"	24.694.23	24.695.23	24.698.23	24.699.23

Revestimiento de
Carburo de Tungsteno

Mango ligero y redondeado, equilibrado



18,5 cm/7¼"

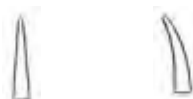

sin cierre

15 cm/6"	24.870.15	24.871.15
18 cm/7"	24.870.18	24.871.18



con cierre

15 cm/6"	24.872.15	24.873.15
18 cm/7"	24.872.18	24.873.18

boca con revestimiento de diamante



Streamlined

con cierre



11 x 0,8 mm

con cierre



11 x 0,8 mm

sin cierre



11 x 0,8 mm

sin cierre



11 x 0,8 mm

15 cm/6"	24.920.15	24.921.15	24.922.15	24.923.15
18 cm/7"	24.920.18	24.921.18	24.922.18	24.923.18
21 cm/8¼"	24.920.21	24.921.21	24.922.21	24.923.21

Titanio



MAXILARIA

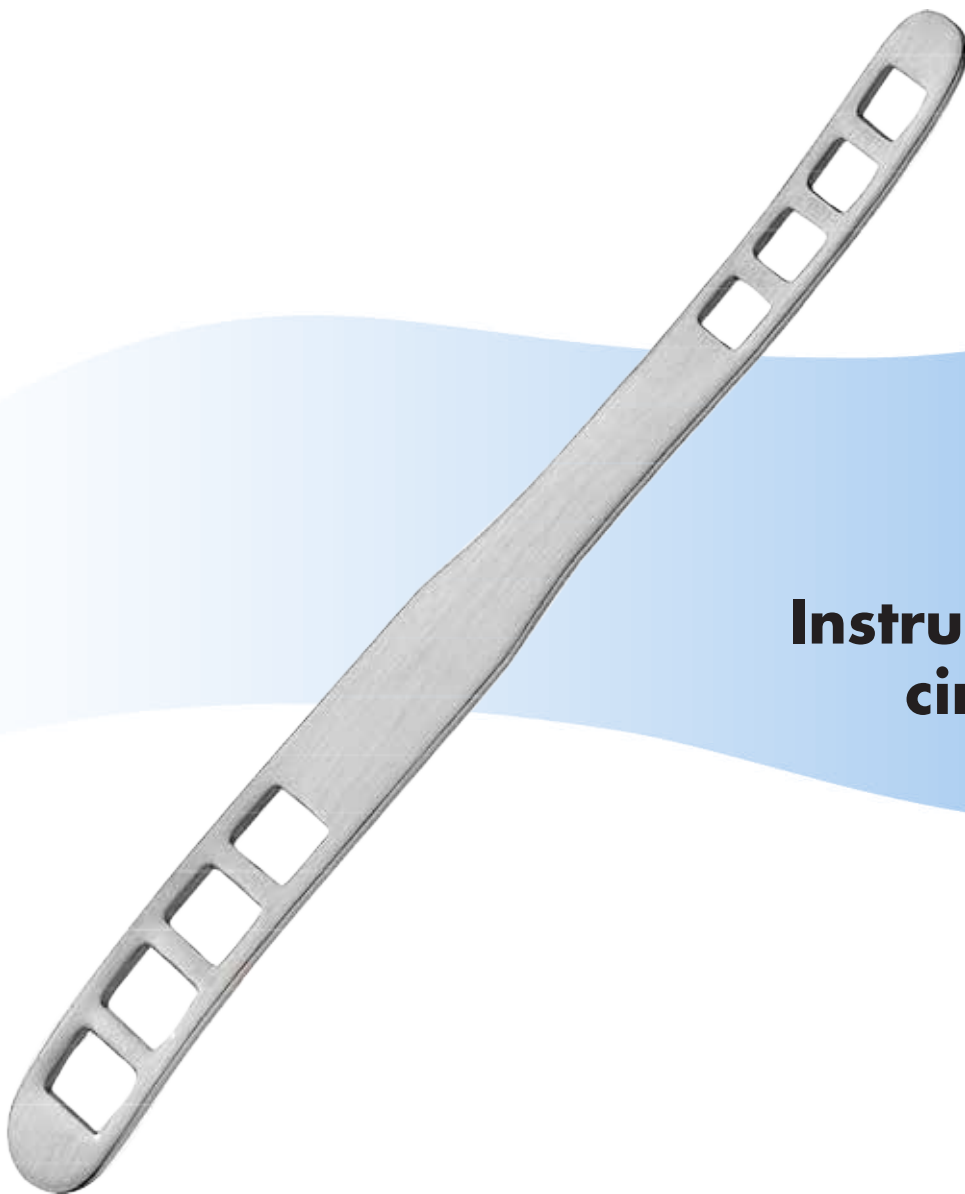

**Instrumentos para
cirugía oral**

Madera
Paquete de 100 unidades



48.102.16
16 cm/6¼"



BRUENINGS
48.107.19
19 cm/7½"
19 / 15 mm



DOYEN



48.112.13
13,5 cm/5¼"
24 / 30 mm



48.112.16
16 cm/6¼"
30 / 34 mm



HARTMANN
48.111.15
15 cm/6"



72 x 23 mm



TOBOLD
48.119.14
14,5 cm/5¾"



85 x 24 mm



TOBOLD
48.119.15
15 cm/6"



88 x 25 mm



48.115.01
14 cm/5½"
36 mm



WIEDER

48.115.02
15 cm/6"
43 mm



STERNBERG
48.229.14
14 cm/5½"



SIMPLEX
48.230.11
11 cm/4¼"



CAWOOD-MINNESOTA
48.233.15
15 cm/6"
20 mm



COLLIN
48.250.16
16 cm/6½"



YOUNG
48.255.16
16 cm/6½"

48.255.99

Bocas de goma, par.



DENHARDT
48.267.12
 12 cm/5"



ROSER-KOENIG
 16 cm/6¼" **48.270.16**
 19 cm/7½" **48.270.19**



HEISTER
48.272.13
 13 cm/5¼"

cuadro metálico con revestimiento de goma sin cadena



McKESSON

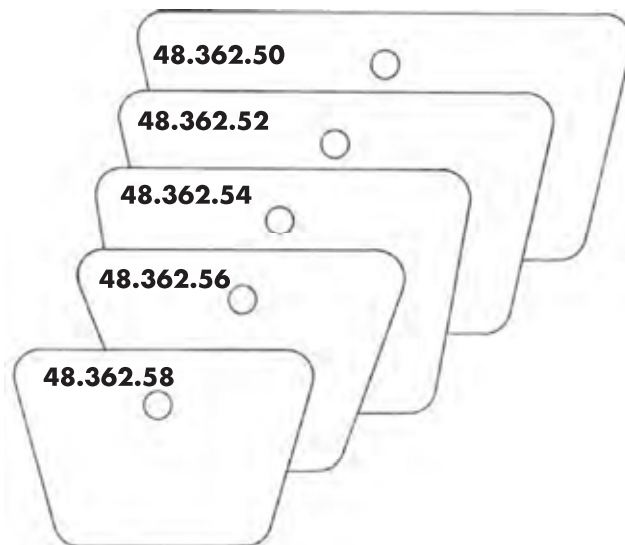

- 48.362.50**
extra grande, para desdentación
- 48.362.52**
grande, para adultos
- 48.362.54**
estándar, para adultos
- 48.362.56**
pequeño, para niños
- 48.362.58**
pequeño, para bebés

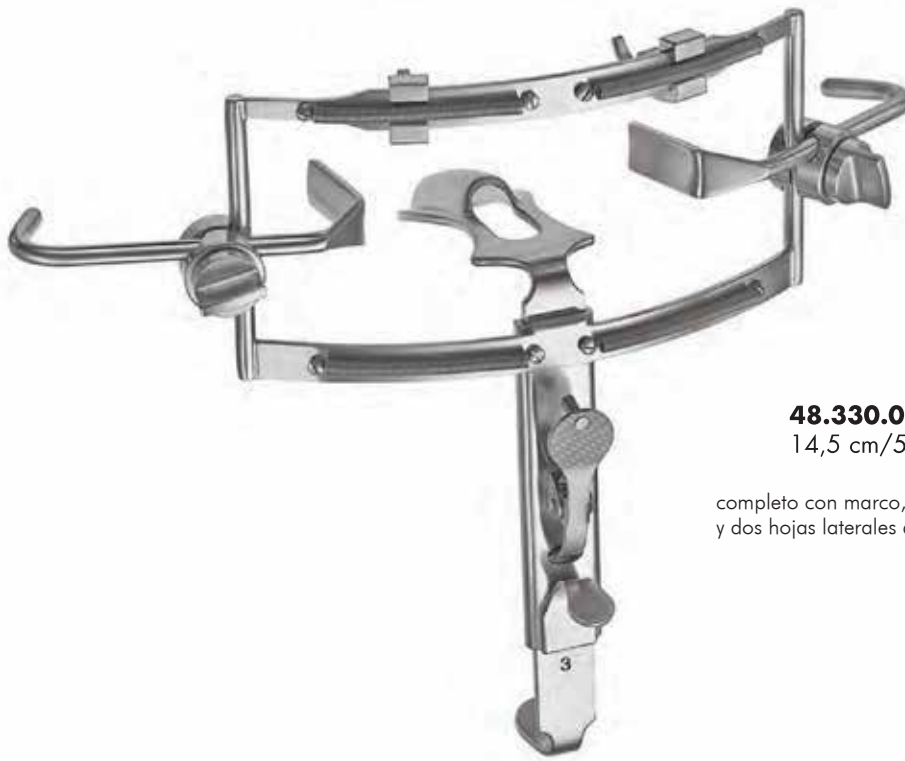

48.330.00
14,5 cm/5¾"

completo con marco, 3 depresores linguales,
y dos hojas laterales ajustables

DINGMANN



DINGMANN
48.330.01
13,5 cm/5¼"
65 x 25 mm



DINGMANN
48.330.02
13,5 cm/5¼"
70 x 29 mm



DINGMANN
48.330.03
13,5 cm/5¼"
80 x 32 mm



MAXILARIA

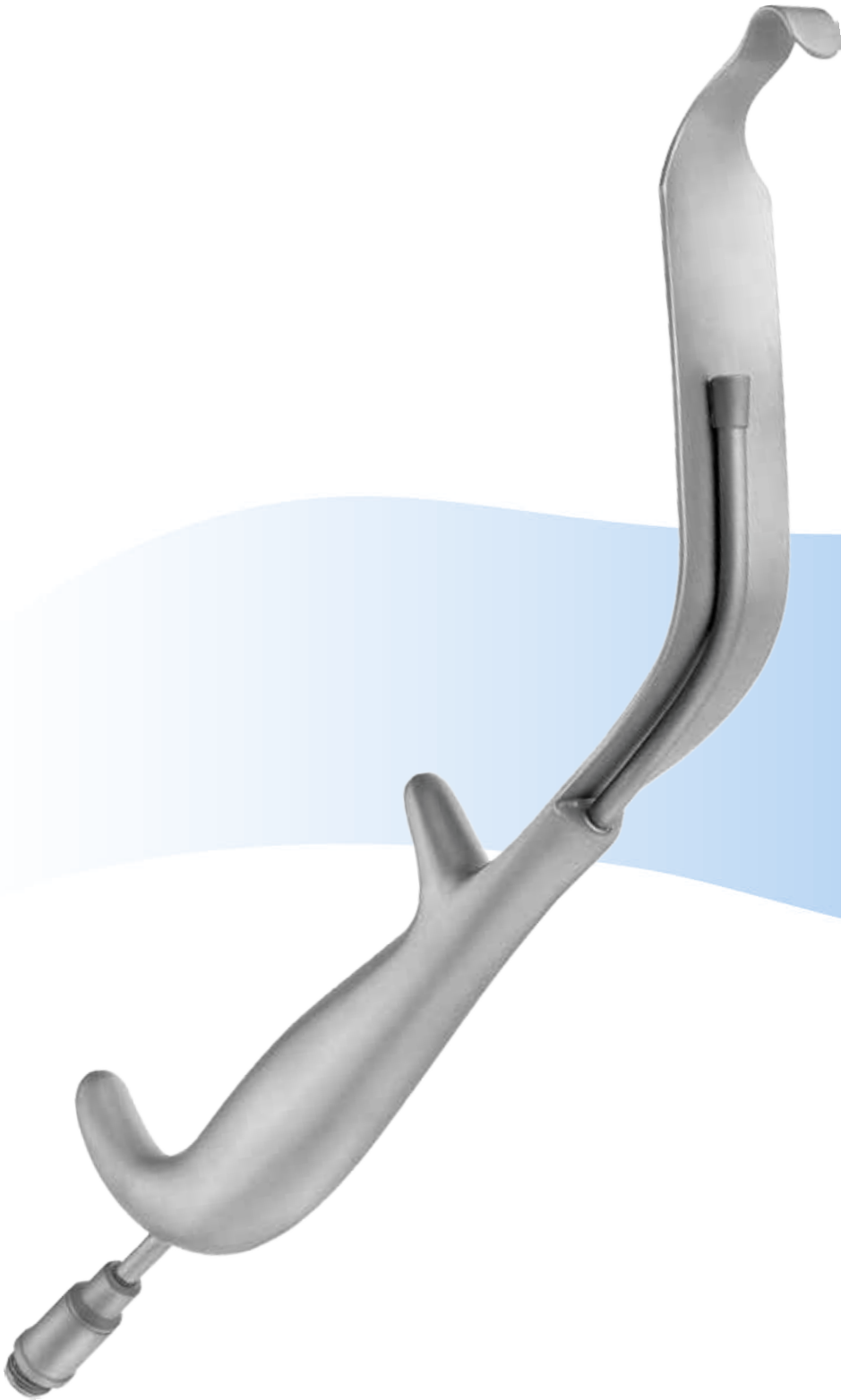

Retractores



MIDDELDORPF

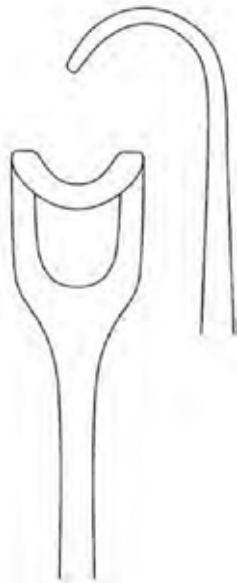

18.344.14
21,5 cm/8½"
14 x 17 mm

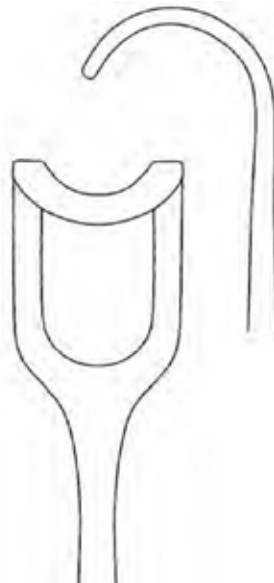

18.344.20
22 cm/8¾"
20 x 22 mm

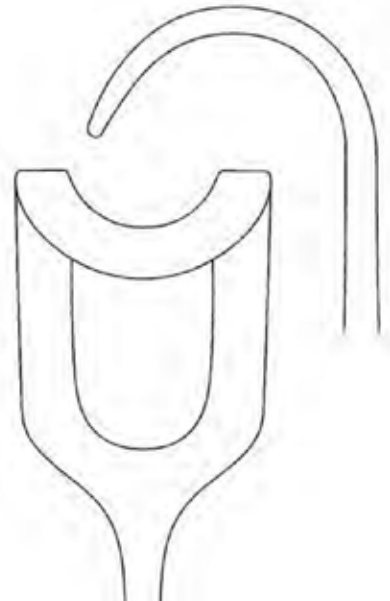

18.344.26
23,5 cm/9¼"
26 x 30 mm



BÜCHS
18.346.20
20,5 cm/8"
38 x 18 mm



GREEN
18.348.22
22,5 cm/8¾"
22 x 22 mm



KIRSCH
20 cm/8"

Retradores diagonales de mejilla para región lateral

para superior izquierda
e inferior derecha



48.588.20
60 x 10 mm

para superior derecha
e inferior izquierda



48.589.20
60 x 10 mm



WARD
48.590.15
15,5 cm/6"



BOWDLER-HENRY
48.590.70
16 cm/6¼"



KAY (AUSTIN)
48.590.73



MUNRO
16 cm/6¼"



48.591.20
20 x 80 mm



48.591.25
25 x 80 mm



48.591.30
30 x 80 mm



48.591.35
35 x 80 mm

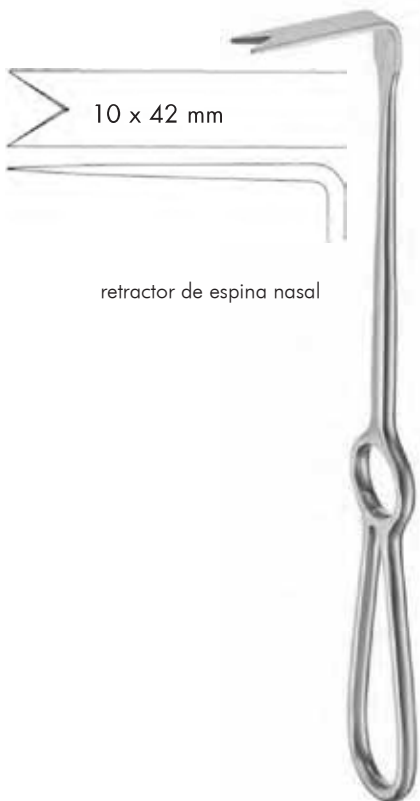

10 x 42 mm

retractor de espina nasal

OBWEGESER
48.595.22
22 cm/8¾"

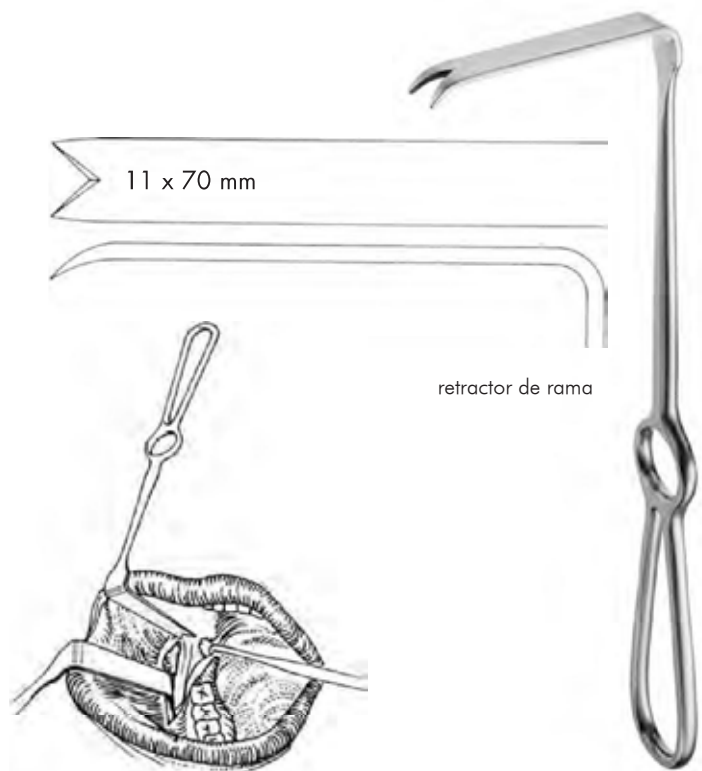

11 x 70 mm

retractor de rama

OBWEGESER
48.597.22
22 cm/8¾"

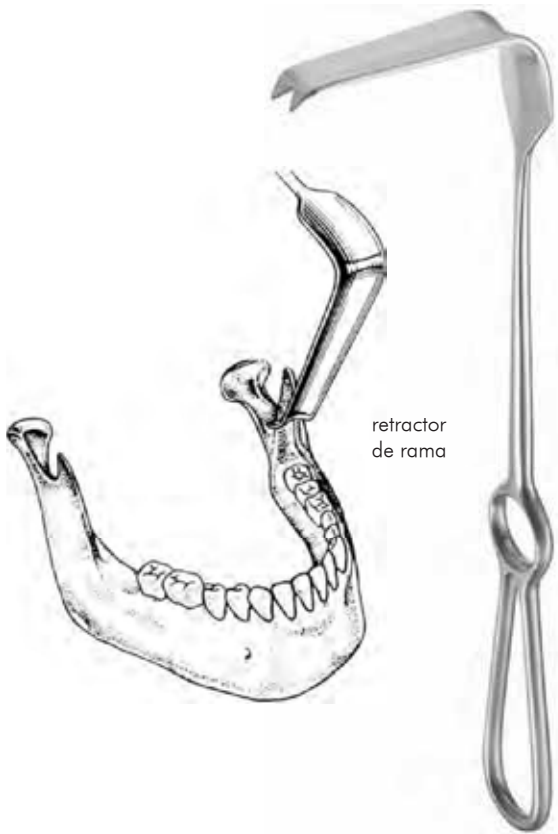

retractor
de rama

OBWEGESER
24,5 cm/9¾"

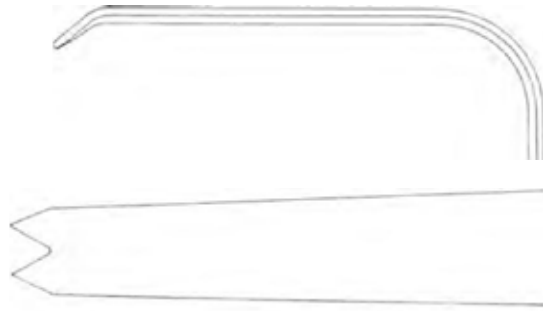

48.602.11
11/15 x 70 mm



48.602.12
12/22 x 70 mm



retractor de tejido blando

OBWEGESER
21,5 cm/8½"

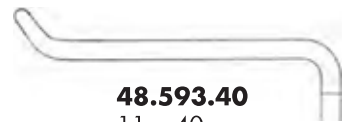

48.593.40
11 x 40 mm

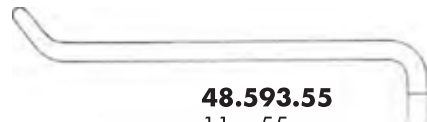

48.593.55
11 x 55 mm



48.593.80
16 x 80 mm



retractor de mentón



16,5 mm

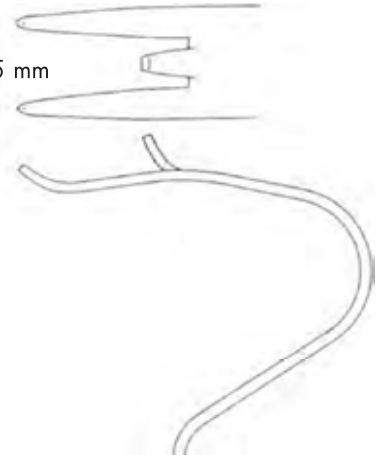

OBWEGESER
48.601.16
16 cm/6¼"

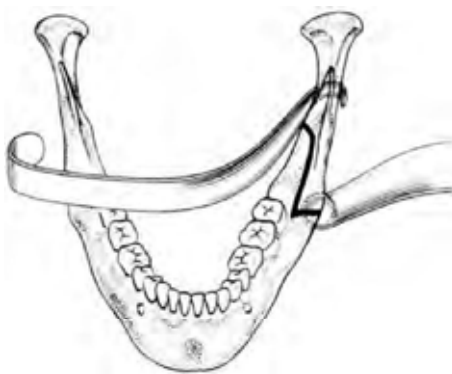

retractor de canal



48.603.08
8 mm



48.603.10
10 mm

OBWEGESER
16,5 cm/6½"

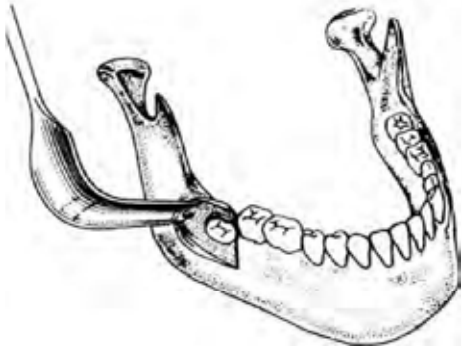

retractor de tercer molar



15/22 x 70 mm

OBWEGESER
48.603.00
24 cm/9½"

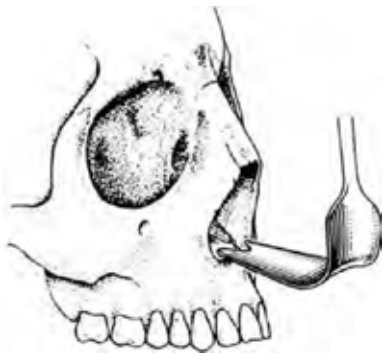

retractor de espina nasal



10/23 x 40 mm

OBWEGESER
48.604.24
24,5 cm/9½"

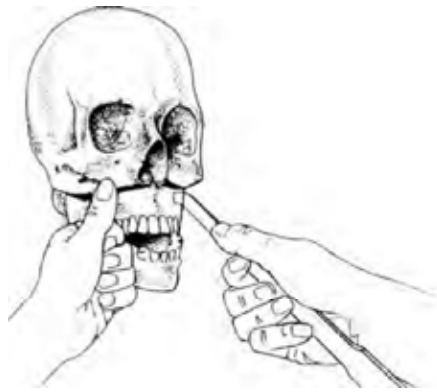

Movilizador maxilar



12 mm

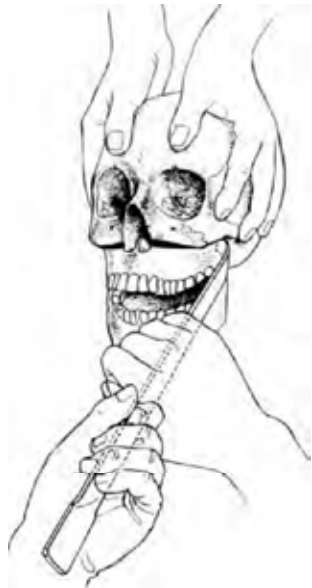

OBWEGESER
48.605.23
23 cm/9"

48.507.02
9 mm
izquierda

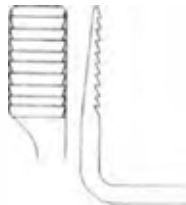

Palanca retromaxilar

48.507.01
9 mm
derecha



TESSIER
15 cm/6"

curvado descendente

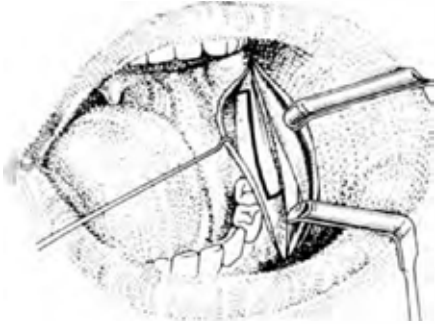

OBWEGESER
24 cm/9½"



48.605.16
5 x 16 mm



48.605.25
7 x 25 mm



48.605.35
10 x 35 mm



48.605.42
10 x 42 mm



48.605.55
12 x 55 mm



48.605.70
14 x 70 mm



48.605.80
16 x 80 mm

curvado ascendente

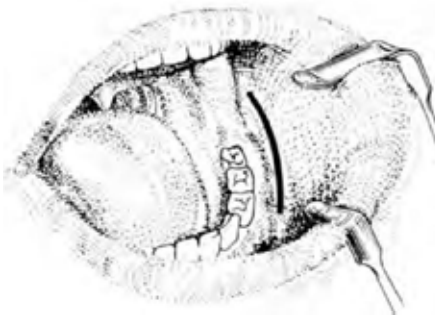

OBWEGESER
24 cm/9½"



48.607.16
5 x 16 mm



48.607.25
7 x 25 mm



48.607.35
10 x 35 mm



48.607.42
10 x 42 mm

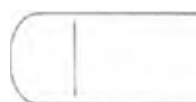

48.607.55
12 x 55 mm



48.607.70
14 x 70 mm

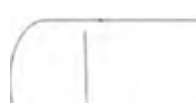

48.607.80
16 x 80 mm



Retractor maleable
cónico

48.781.10
10 - 12 mm
Fig. A

48.781.15
15 - 17 mm
Fig. B

48.781.20
20 - 22 mm
Fig. C

48.781.00
Fig. A/B/C
Satz von 3
Set of 3

TESSIER
22 cm/8¾"



20 x 7 / 38 x 10 mm

TESSIER
48.783.01
15 cm/6"

48.785.01
20 x 12 / 30 x 16 mm

48.785.02
30 x 12 / 35 x 16 mm

48.785.03
35 x 12 / 45 x 16 mm

48.785.00
Set de 3



TESSIER
15,5 cm/6"

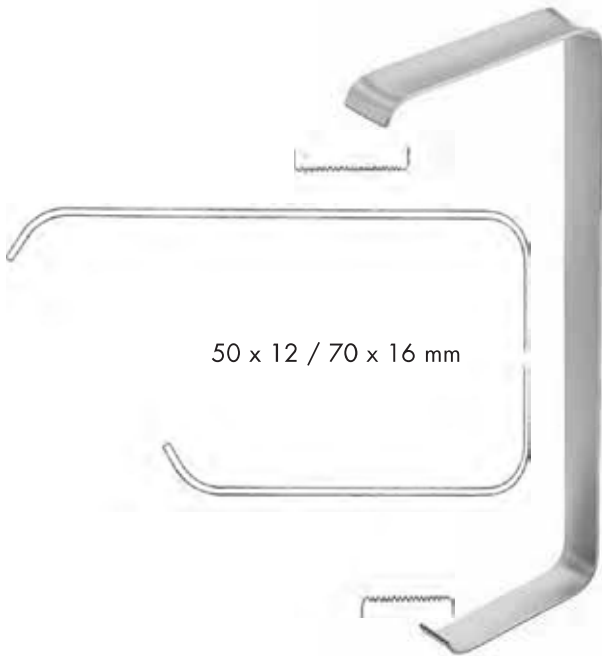

50 x 12 / 70 x 16 mm

TESSIER
48.787.50
15,5 cm/6"



TESSIER
14,5
cm/5¾"



48.795.10
10 mm



48.795.17
17,5 mm



48.795.20
20 mm

Cromado negro



TESSIER
16 cm/6¼"



48.789.30
30 x 12 / 35 x 16 mm



48.789.35
35 x 12 / 45 x 16 mm



48.789.50
50 x 12 / 70 x 16 mm

Set de 3 **48.789.00**



48.791.01
Fig. 1
8 mm



48.791.02
Fig. 2
10 mm



48.791.03
Fig. 3
7 mm



48.791.05
Fig. 5
8 mm



48.791.06
Fig. 6
12 mm



48.791.04
Fig. 4
10 mm



TESSIER
12,5 cm/5"



TESSIER
12,5 cm/5"

Retractor de escotadura sigmoidea.
Hoja cóncava, curva

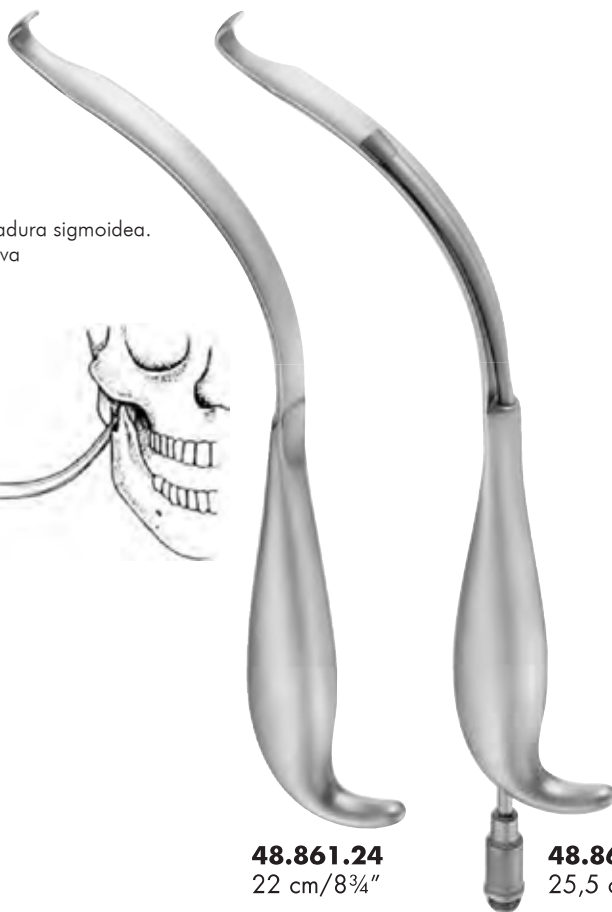
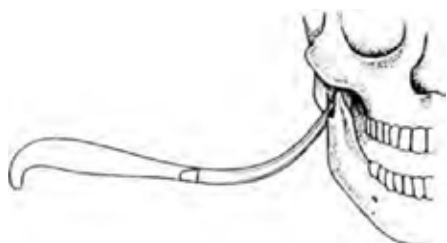

9,5 mm /
16mm

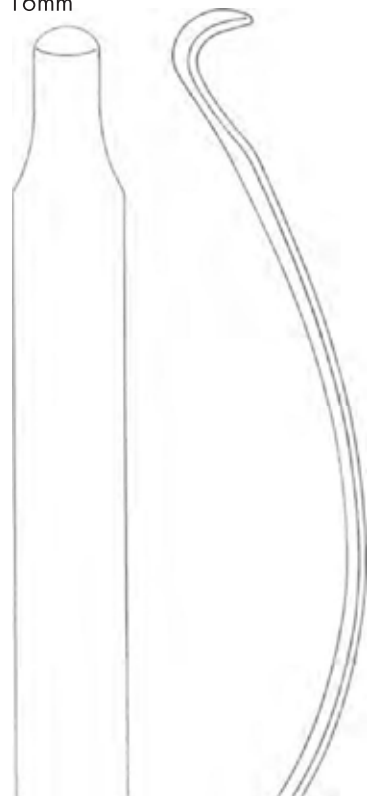

48.861.24
22 cm/8¾"

48.863.27
25,5 cm/10"

Retractor de pterigoide para LeFort

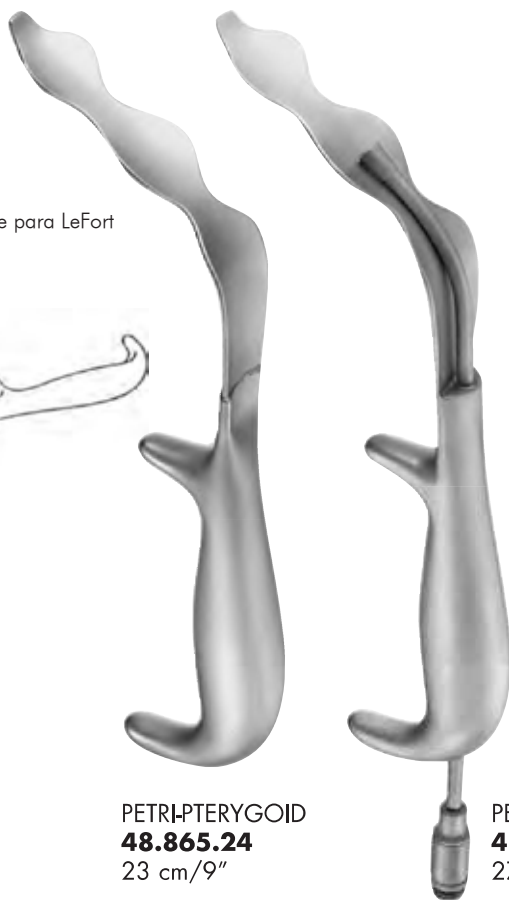
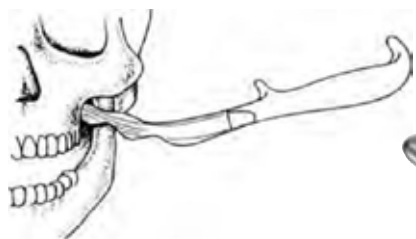

25,5 mm

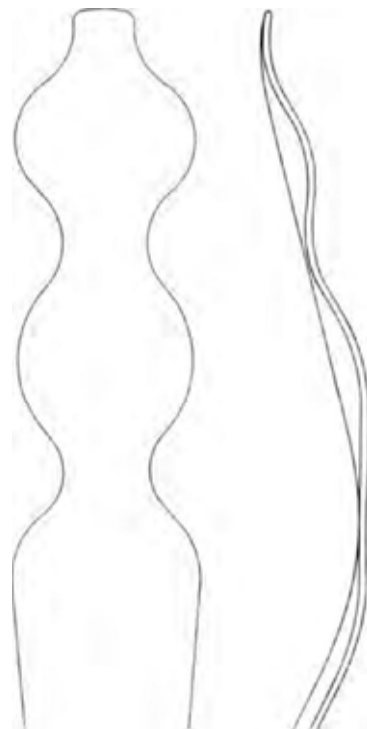

PETRI-PTERYGOID
48.865.24
23 cm/9"

PETRI-PTERYGOID
48.867.27
27 cm/10¾"

rechts
right

links
left

rechts
right

links
left

26,5 mm / 16mm

Retractor intraoral
de escotadura sigmoidea

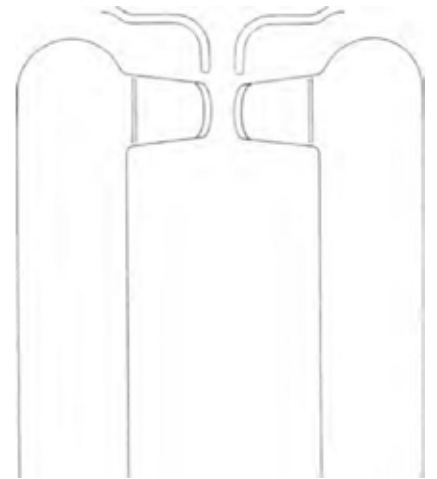
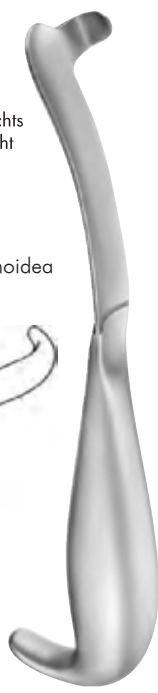
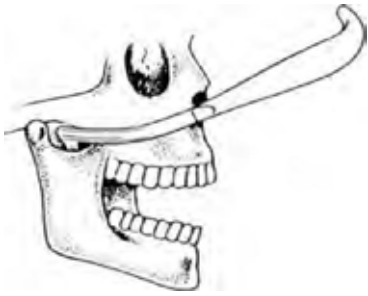

BAUER
48.869.21
21 cm/8¼"

BAUER
48.871.21
21 cm/8¼"

BAUER
48.873.24
24,5 cm/9¾"

BAUER
48.875.24
24,5 cm/9¾"

Retractor intraoral
L&M para osteotomía vertical intraoral

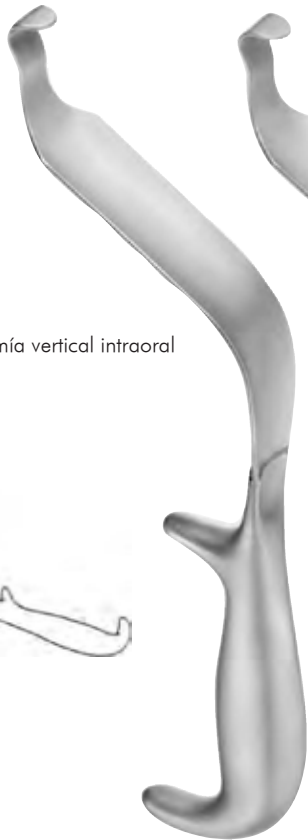
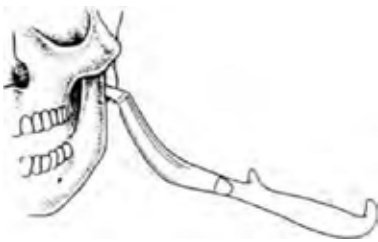

12,5 mm /
27 mm

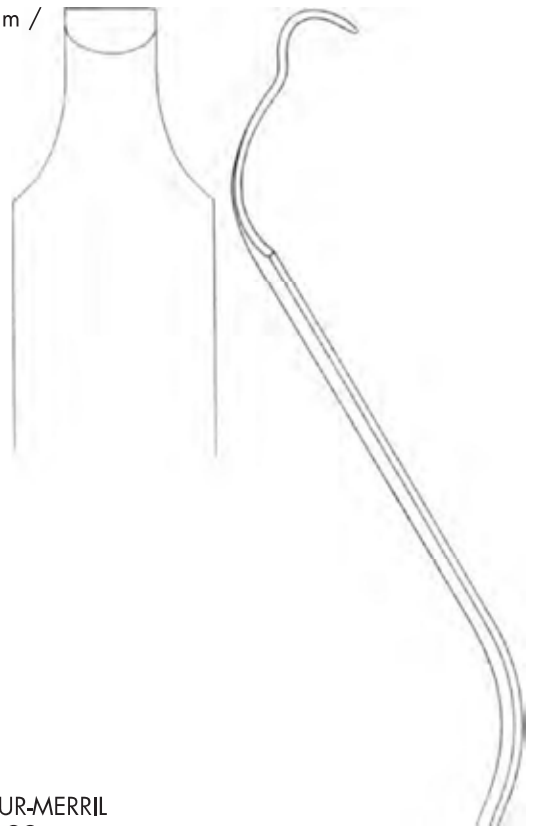

LEVASSEUR-MERRIL
48.877.25
25 cm/9¾"

LEVASSEUR-MERRIL
48.879.28
28 cm/11"

Retractor multi-función

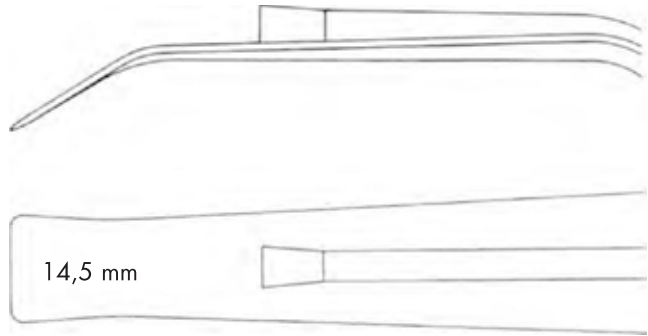

con transportador
de fibra óptica
SHEA
48.883.24
22 cm/8¾"

sin transportador
de fibra óptica
SHEA
48.881.18
18 cm/7"

Retractor para cuerpo mandibular

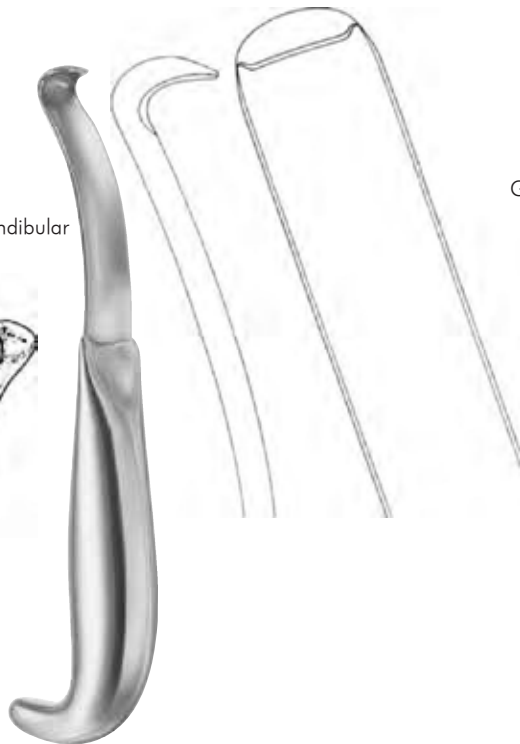
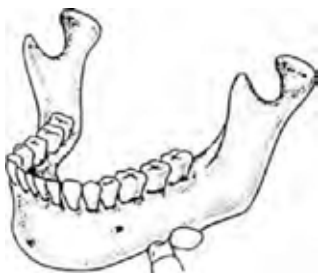

HARGIS
48.823.18
18 cm/7"

Gancho para cigomático



DINGMAN
19 cm/7½"

48.541.10
10 mm

48.541.20
10 mm



MAXILARIA

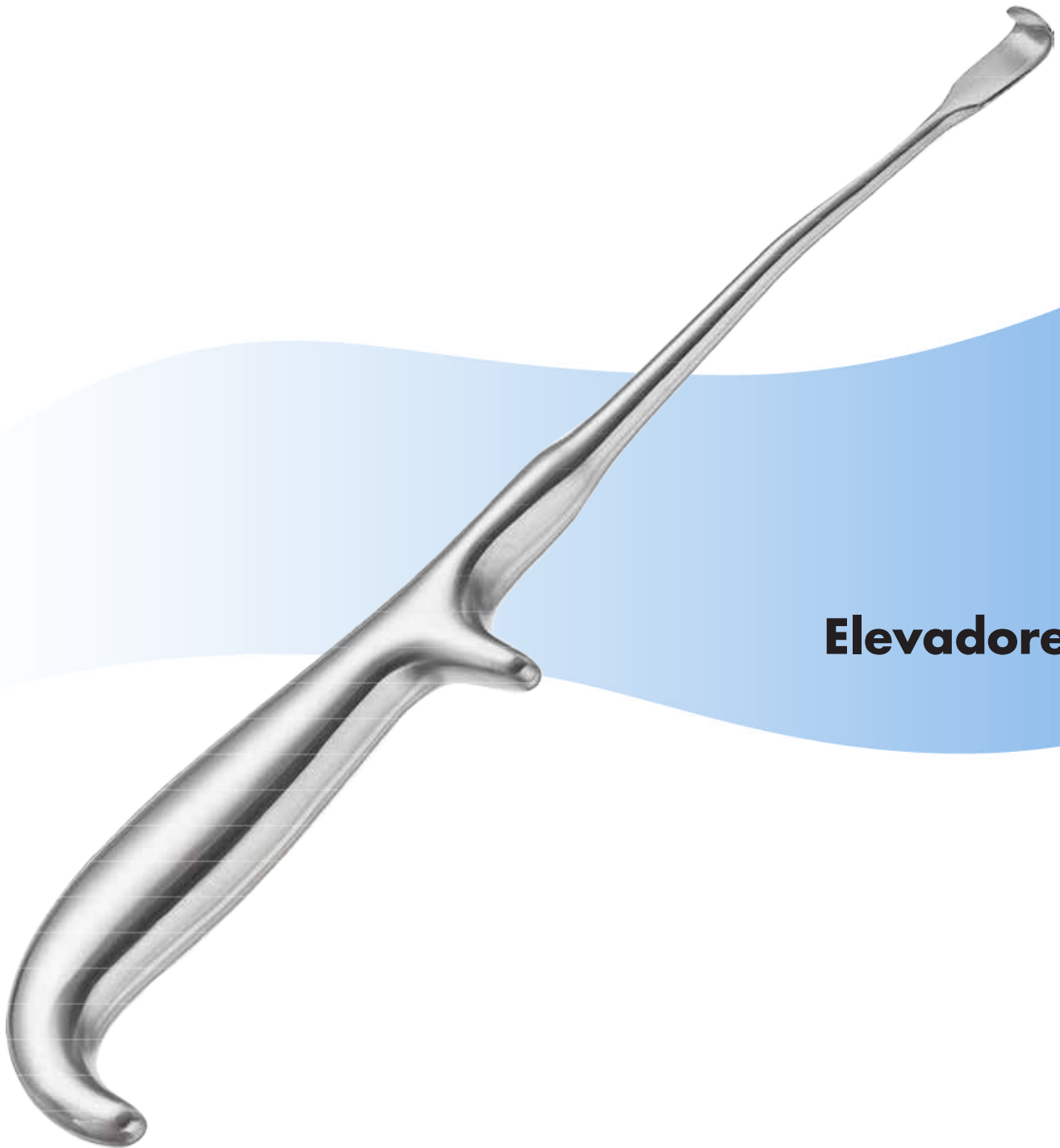

Elevadores

Elevador malar
para arcos cigomáticos



GILLIES
48.497.20
20 cm/8"

Elevador de
hueso cigomático



Ø 5,0 mm
Spitze
Tip

DINGMANN
48.497.21
21 cm/8¼"



ROWE
48.551.25
25,5 cm/10"



48.608.06 48.608.07 48.608.09 48.608.11
6 mm 7 mm 9 mm 11 mm



48.609.06 48.609.07 48.609.09 48.609.11
6 mm 7 mm 9 mm 11 mm

corte angulado



OBWEGESER
18 cm/7"

corte plano

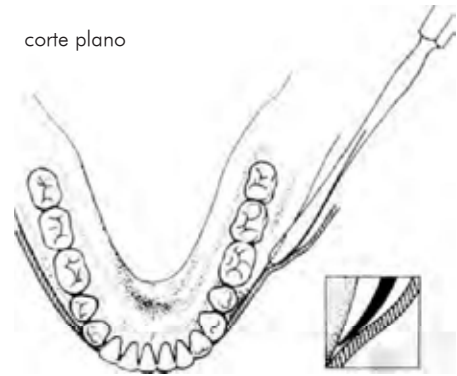

OBWEGESER
18 cm/7"

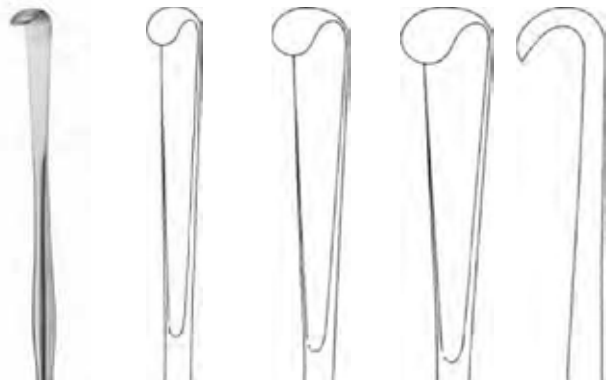

48.611.05 48.611.07 48.611.09
5 mm 7 mm 9 mm

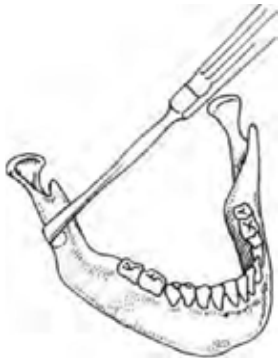

OBWEGESER
20 cm/8"

Raspadores con horquilla



7,5 mm



OBWEGESER
48.612.01
17,5 cm/7"

OBWEGESER
48.612.02
17,5 cm/7"



OBWEGESER
48.614.21
20,5 cm/8"



OBWEGESER
48.616.21
21 cm/8¼"



OBWEGESER-FREER
48.619.20
20,5 cm/8"

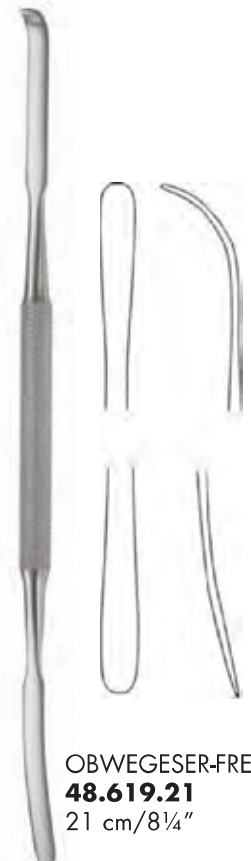

OBWEGESER-FREER
48.619.21
21 cm/8¼"

5,5 mm
afilado



10 mm
afilado

OBWEGESER
48.621.10
20,5 cm/8"



5 mm
afilado

48.623.01
ligeramente curvo

48.623.02
fuertemente curvo

5 mm
romo

SALZBURG
24,5 cm/10"

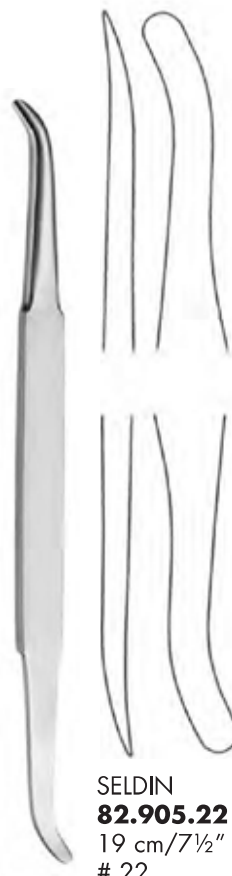

SELDIN
82.905.22
19 cm/7½"
22

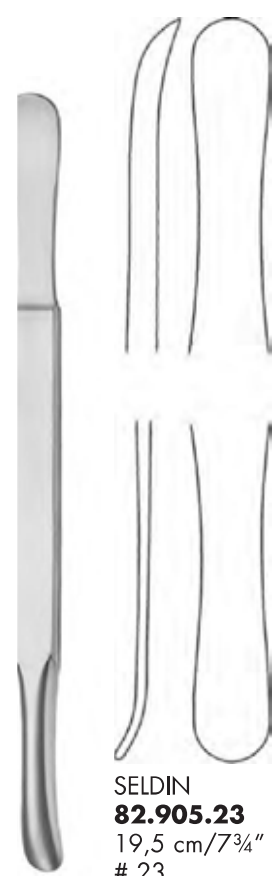

SELDIN
82.905.23
19,5 cm/7¾"
23

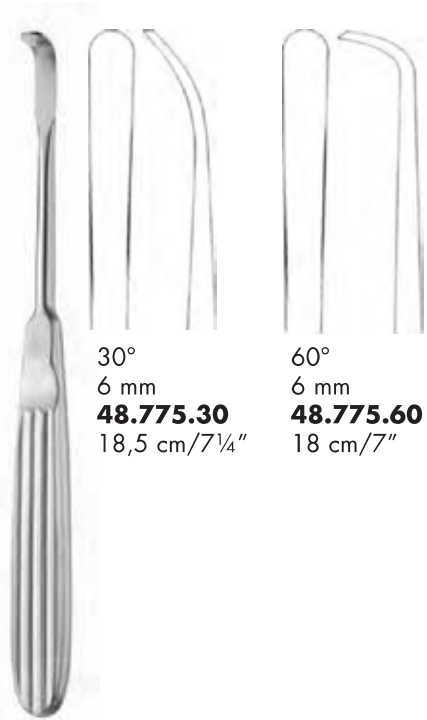

30°
6 mm
48.775.30
18,5 cm/7¼"

60°
6 mm
48.775.60
18 cm/7"

TESSIER

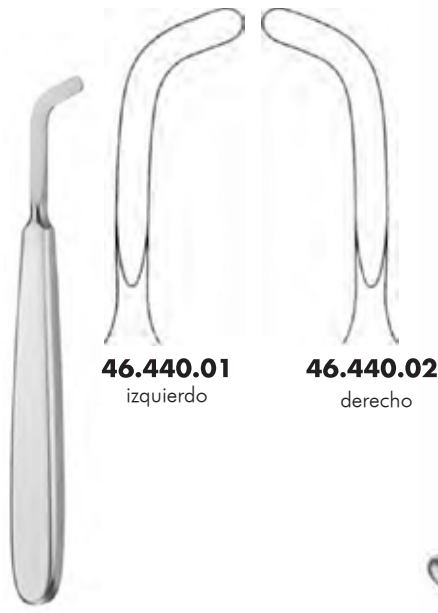

46.440.01
izquierdo

46.440.02
derecho

14 cm/5½"

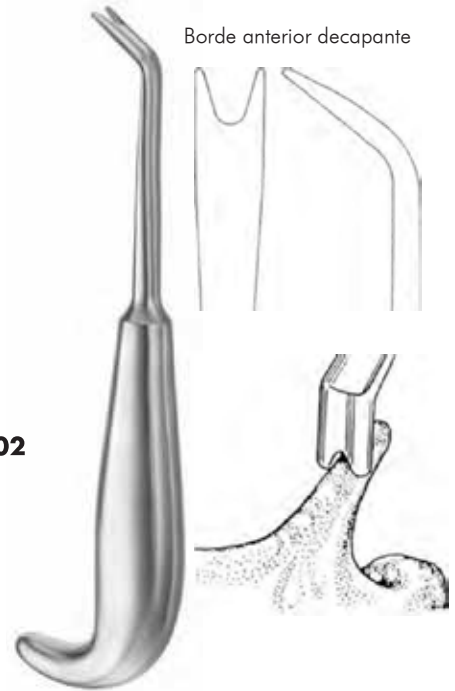

Borde anterior decapante

HARGIS
48.825.19
19 cm/7½"

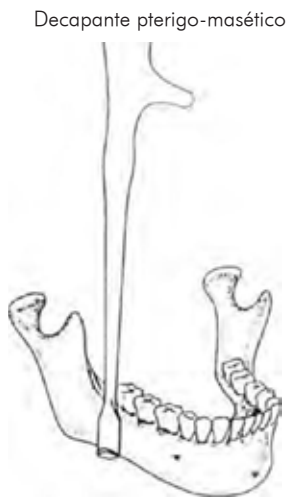

Decapante pterigo-masético



HARGIS
23 cm/9"

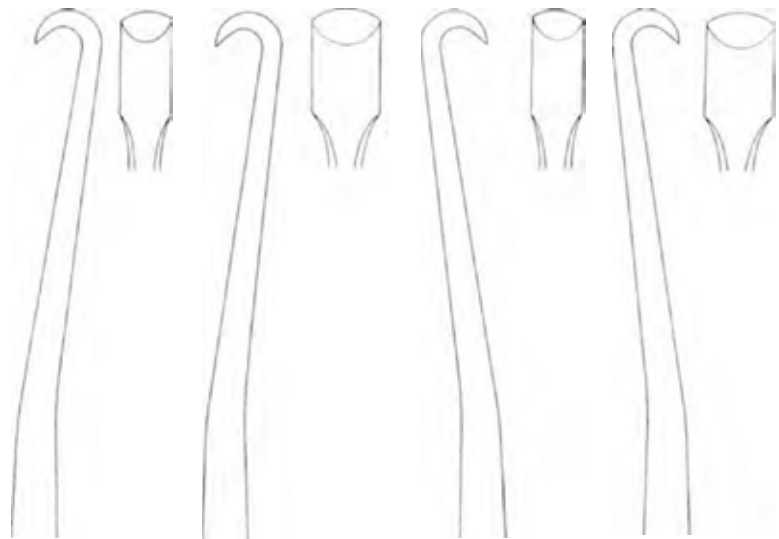

48.828.65
6,5 mm
derecho, romo

48.828.90
9,0 mm
derecho, romo

48.829.65
6,5 mm
izquierdo, romo

48.829.90
9,0 mm
izquierdo, romo



MAXILARIA



**Osteotomos, martillos
y escofinas**

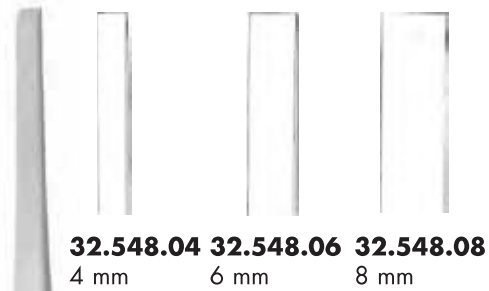

32.548.04 4 mm
32.548.06 6 mm
32.548.08 8 mm

MARCHAC
 18,5 cm/7¼"



32.549.06
 6 mm
 curvado

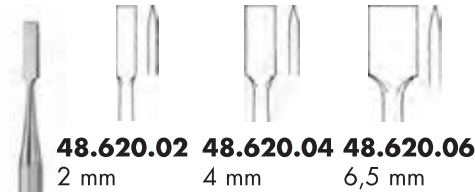

48.620.02 2 mm
48.620.04 4 mm
48.620.06 6,5 mm

OBWEGESER
 15 cm/6"

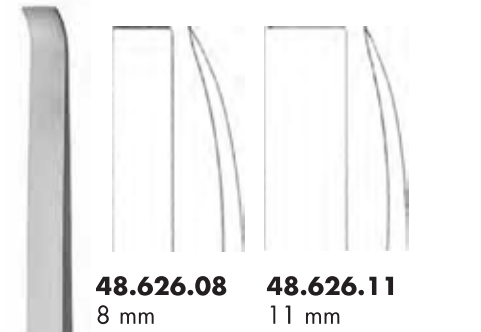
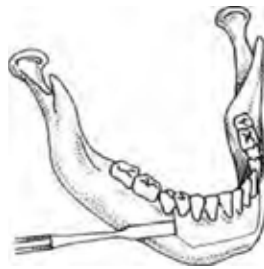

48.626.08 8 mm
48.626.11 11 mm

Osteotomos para
 tubérculo maxilar

OBWEGESER
 23,5 cm/9¼"

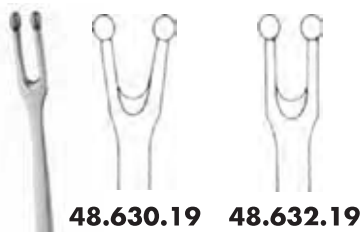
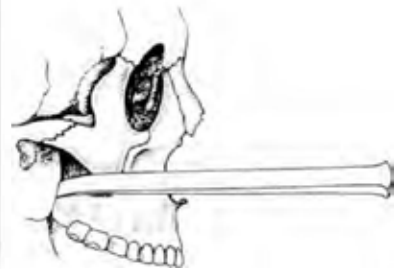

48.630.19 4 mm
48.632.19 6 mm

OBWEGESER
 18,5 cm/7¼"

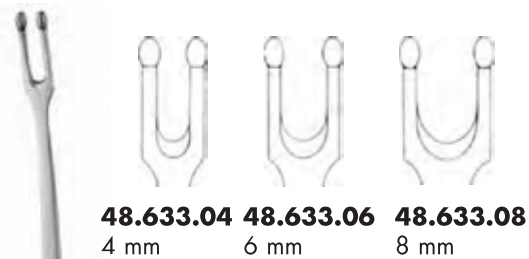

48.633.04 4 mm
48.633.06 6 mm
48.633.08 8 mm

OBWEGESER
 18,5 cm/7¼"

Osteotomo
 nasal-septonasal

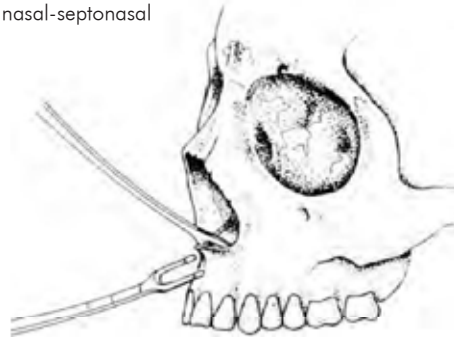



48.680.08 8 mm
48.680.12 12 mm
48.680.16 16 mm



OBWEGESER
22 cm/8¾"

Osteotomo con calzo

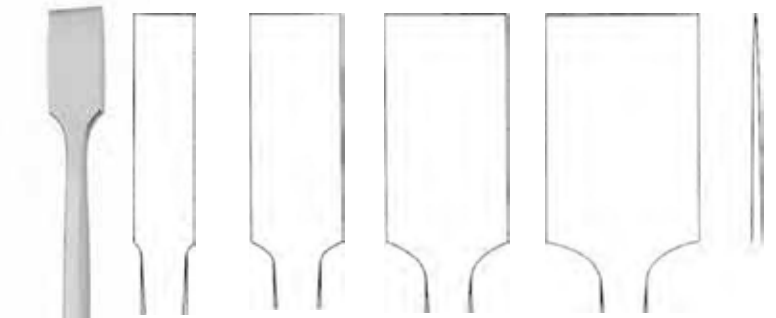

48.682.08 8 mm
48.682.12 12 mm
48.682.16 16 mm
48.682.20 20 mm



OBWEGESER
22 cm/8¾"

Osteotomo con filo

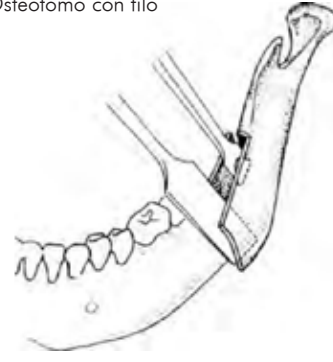

48.690.10 10 mm
48.690.20 20 mm



HARGIS
21,5 cm/8½"

Osteotomo para rama

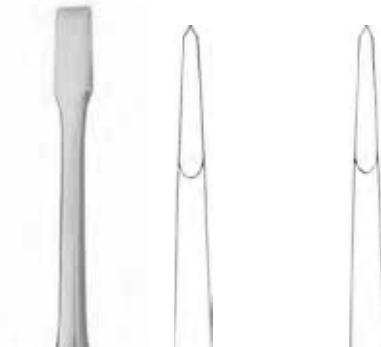

48.692.07 7 mm
48.692.10 10 mm



OBWEGESER
22 cm/8¾"

Osteotomo con calzo

Osteotomo para proceso alveolar

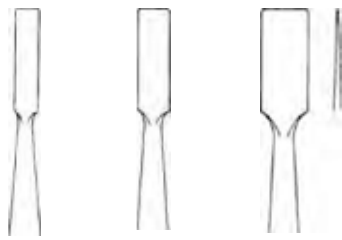

48.684.03 3 mm
48.684.04 4 mm
48.684.06 6,5 mm

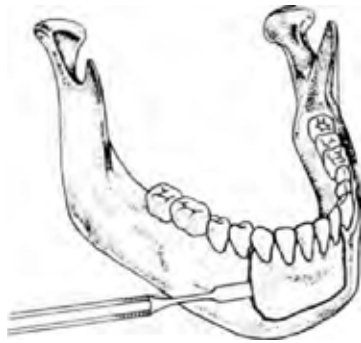

OBWEGESER
 15,5 cm/6"

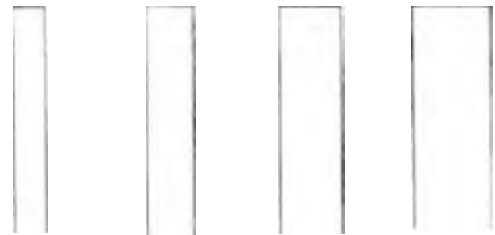

48.740.04 4 mm
48.740.06 6 mm
48.740.08 8 mm
48.740.10 10 mm

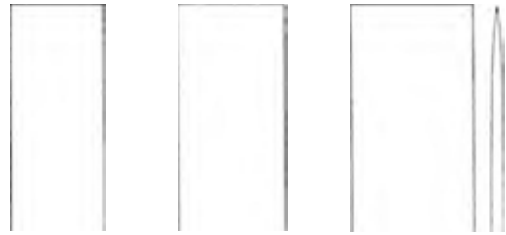

48.740.12 12 mm
48.740.14 14 mm
48.740.16 16 mm

DAUTREY-MUNRO
 16 cm/6¼"

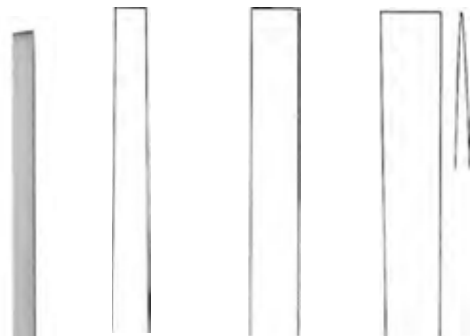

48.742.04 4 x 1,2 mm
48.742.06 6 x 1,2 mm
48.742.08 8 x 1,2 mm

EPKER
 18 cm/7"

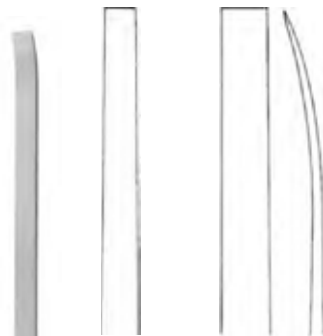

48.743.04 4 x 1,2 mm
48.743.06 6 x 1,2 mm

EPKER
 18 cm/7"



48.745.06 6 x 1,2 mm
48.745.08 8 x 1,2 mm

EPKER
 18 cm/7"



para injertos de ilion y tibia



48.754.10 10 mm **48.754.15** 15 mm **48.754.20** 20 mm **48.754.30** 30 mm



48.755.10 10 mm **48.755.15** 15 mm

TESSIER
20 cm/7¾"



48.756.10 10 mm **48.756.15** 15 mm

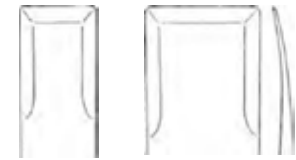

48.757.10 10 mm **48.757.15** 15 mm

TESSIER
16 cm/6¼"



Cabeza
ø 27 mm

Peso
140 g

HAJEK
32.687.22
22 cm/8¾"



Cabeza
ø 30 mm

Peso
300 g

COTTLE
32.689.24
19 cm/7½"
plano / convexo



Cabeza
ø 25 mm

Peso
135 g

32.691.14
18,5 cm/7¼"
32.691.99
Par de repuestos **32.691.14**



Cabeza
Ø 20 mm

Peso
140 g

WILLIGER
32.695.14
16,5 cm/6½"



Relleno de plomo

Cabeza
Ø 22 mm

Peso
155 g

32.696.19
19 cm/7½"



32.697.02

Par de repuesto
Plástico (Nylon)

Cabeza
Ø 27 mm

Peso
320 g

MEAD
32.696.32
17 cm/6¾"

Revestimiento y bocas de
Carburo de Tungsteno



½

FOMON
20 cm/8"



46.522.01
Fig. 1/2



46.522.03
Fig. 3/4



46.522.05
Fig. 5/6



46.522.07
Fig. 7/8

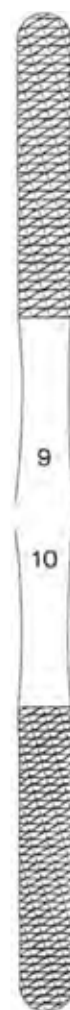

46.522.09
Fig. 9/10



MAXILARIA

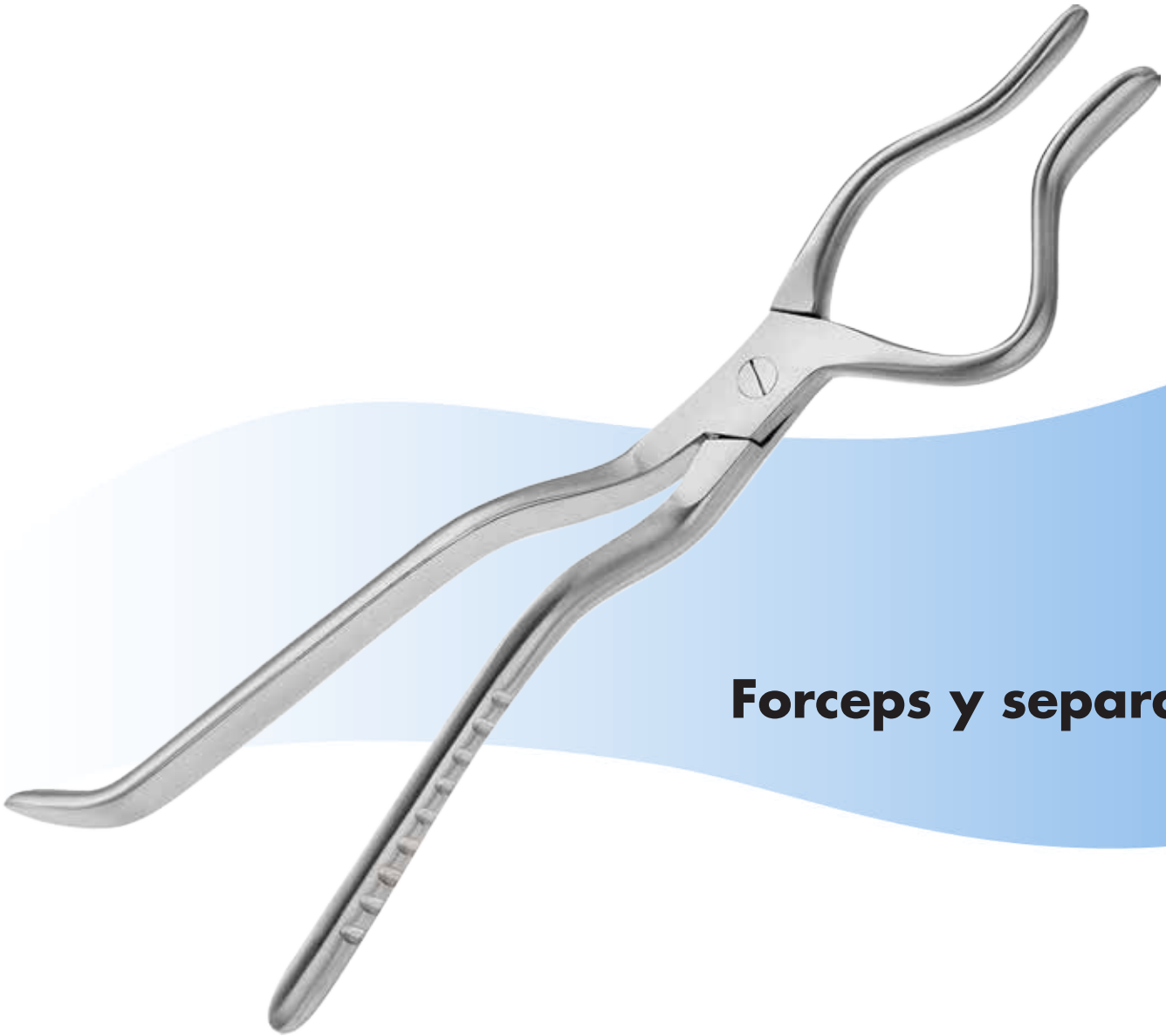

Forceps y separadores



HALSTED-MOSQUITO



12.220.12
12.224.12
12,5 cm/5"



12.220.14
14,5 cm/5¾"



12.221.12
12.225.12
12,5 cm/5"



12.221.14
14,5 cm/5½"



12.230.12
12.234.12
12,5 cm/5"



12.230.14
14,5 cm/5¾"



12.231.12
12.235.12
12,5 cm/5"



12.231.14
14,5 cm/5½"

Titanio



12.345.14 **12.347.14**

curvado lateralmente

DANDY
14,5 cm/5¾"

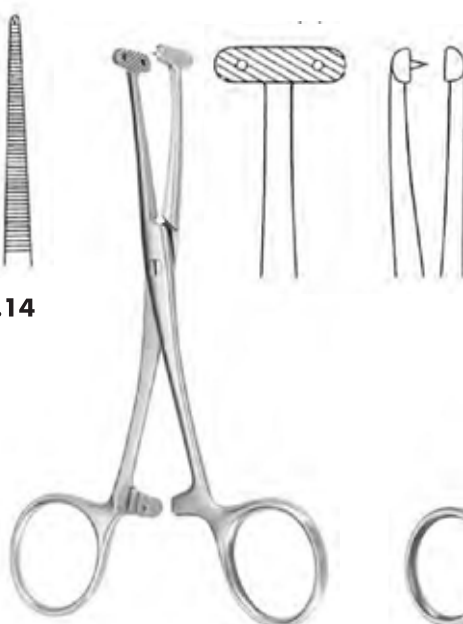

MARTEL
12.364.14
14 cm/5½"



WILLET-MARTEL
12.366.19
19 cm/7½"

Pinzas de reposición especiales para maxilar

Pinzas de reposición para pequeños fragmentos



32.403.09
9,5 cm/3¾"



32.403.13
13,5 cm/5¼"



32.409.13
13,5 cm/5¼"



STEINHAEUER
32.404.01
13 cm/5"



STEINHAEUER
32.404.02
13 cm/5"



LEWIN
32.402.17
17,5 cm/7"



32.386.20
20 cm/8"



DINGMANN
32.407.19
19 cm/7½"



32.408.01
relieve suave

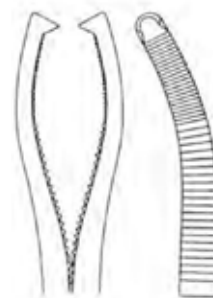

32.408.02
relieve marcado

para separación sagital

JETER-VAN SICKELS
18 cm/7"

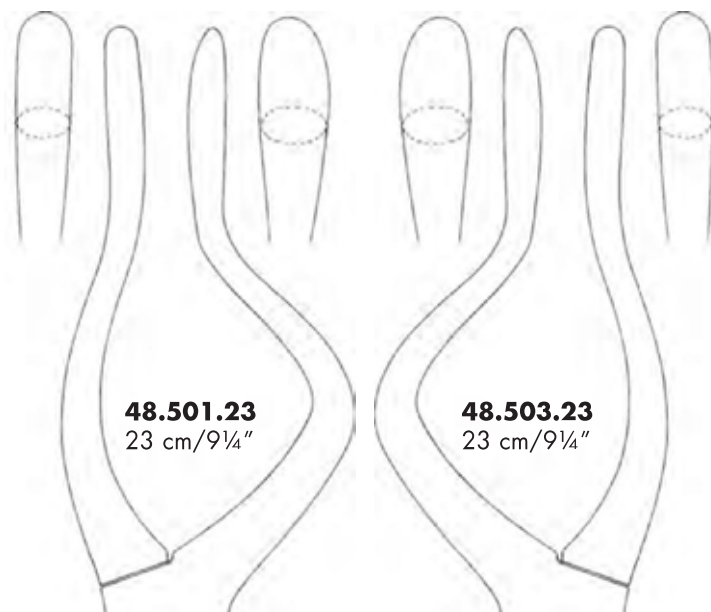
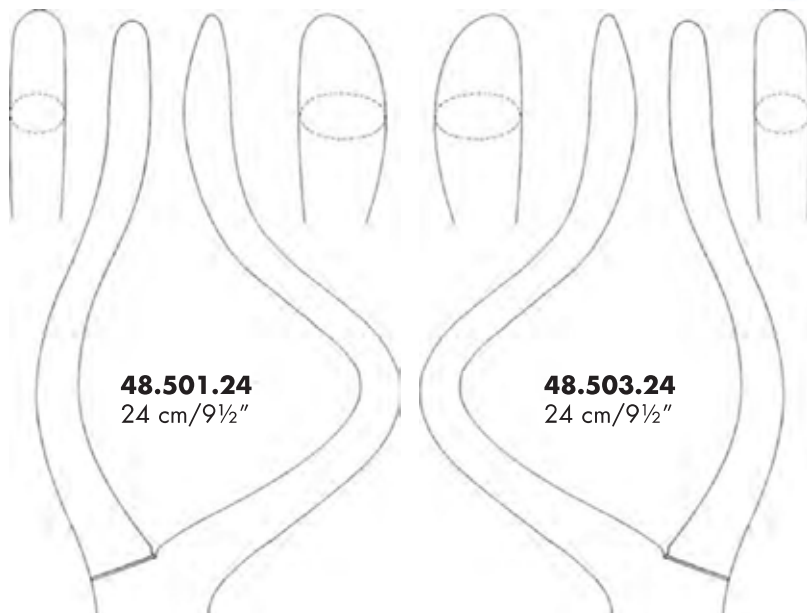

ROWE
izquierda

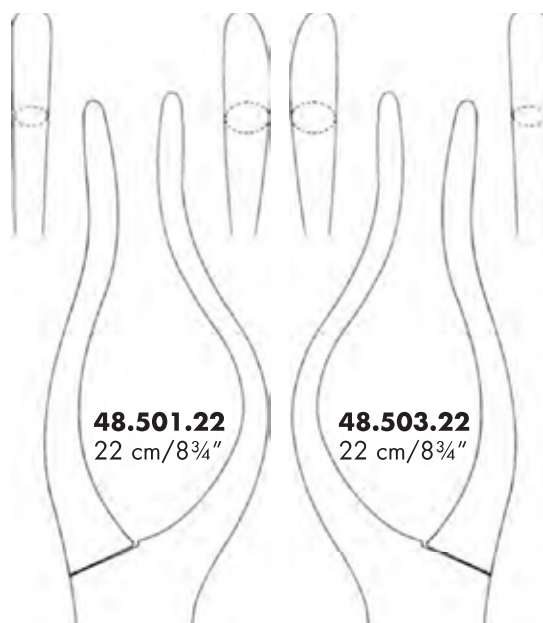

ROWE
derecha

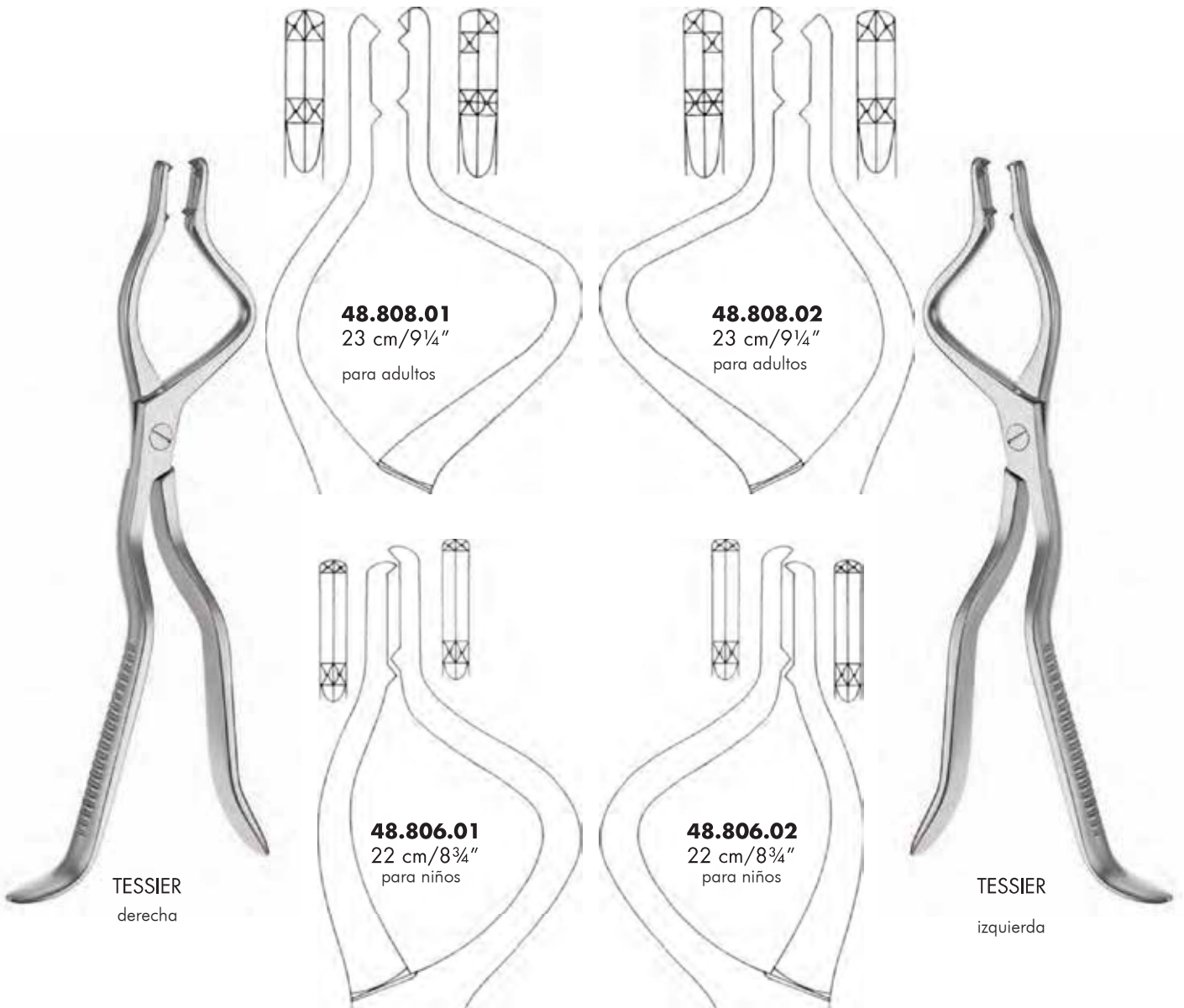

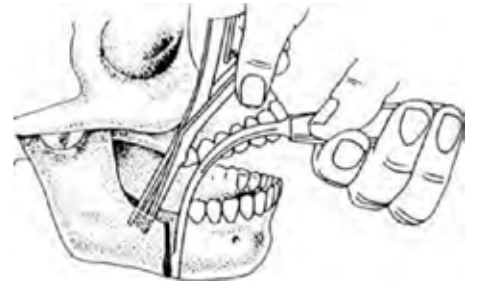

Forceps para contorno de hueso



11 mm



TESSIER
48.799.22
22 cm/8¾"

Separador de rama



12 mm

48.838.20
sin carraca

48.840.20
con carraca



TESSIER
48.802.18
17,5 cm/7"



SMITH
48.838.20
23,5 cm/9¼"

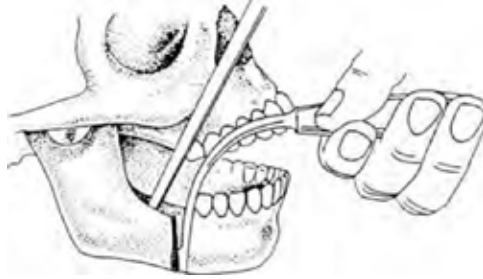

9 mm
derecha

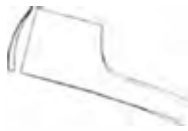

9 mm
izquierda



SMITH
48.835.01
18,5 cm/7¼"

SMITH
48.835.02
18,5 cm/7¼"



MAXILARIA



**Instrumental
de cerclaje**



blando, rollo de 10m



ERICH
48.529.00

Rollo 1 m

- | | |
|------------------------------|------------------------------|
| 33.530.02
ø 0,2 mm | 33.530.08
ø 0,8 mm |
| 33.530.03
ø 0,3 mm | 33.530.09
ø 0,9 mm |
| 33.530.04
ø 0,4 mm | 33.530.10
ø 1,0 mm |
| 33.530.05
ø 0,5 mm | 33.530.12
ø 1,2 mm |
| 33.530.06
ø 0,6 mm | 33.530.15
ø 1,5 mm |
| 33.530.07
ø 0,7 mm | |



ERICH
48.529.13
14 cm/5½"



OBWEGESER
48.650.15
15,5 cm/6¼"

Revestimiento de
Carburo de Tungsteno



BARMESH
48.583.13
13,5 cm/5½"



18 cm/7"



33.533.01



33.533.02



33.533.03



33.528.01 **33.528.02** **33.528.03**

15 cm/6" 15 cm/6" 16 cm/6¼"



33.528.04
18 cm/7"

AUTOMATIC



Revestimiento de Carburo de Tungsteno

BAUMGARTNER

33.599.20

20 cm/8"



33.601.15

15 cm/6"



BERRY

33.601.19

19 cm/7½"

Revestimiento de
Carburo de Tungsteno



Eine Schneide gezahnt
One toothed cutting edge

08.831.12
12 cm/4¾"



Eine Schneide gezahnt
One toothed cutting edge

08.835.12
12 cm/4¾"



HARVEY
08.838.12
12,5 cm/5"

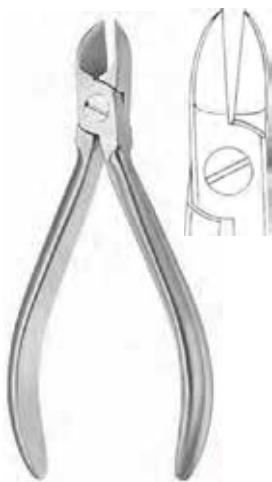

OBWEGESER
48.650.12
12 cm/4¾"



33.545.16
17 cm/6¾"



33.545.22
22,5 cm/8¾"



OBWEGESSER
48.647.13
13 cm/5"



OBWEGESSER
48.647.15
15 cm/6"

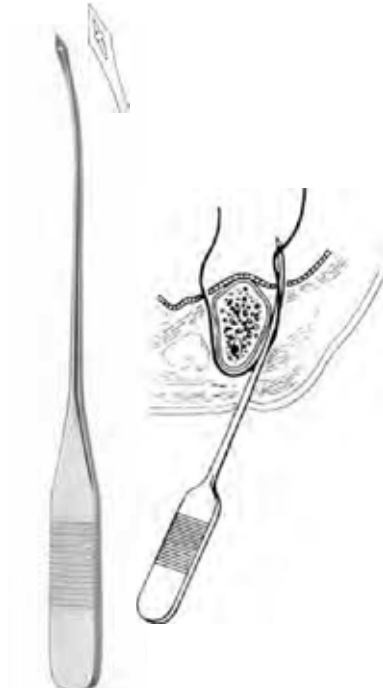

OBWEGESSER
48.647.17
17,5 cm/7"



KELSEY FRY
48.636.15
15 cm/6"

recto



KELSEY FRY
48.637.18
18 cm/7"

curvado

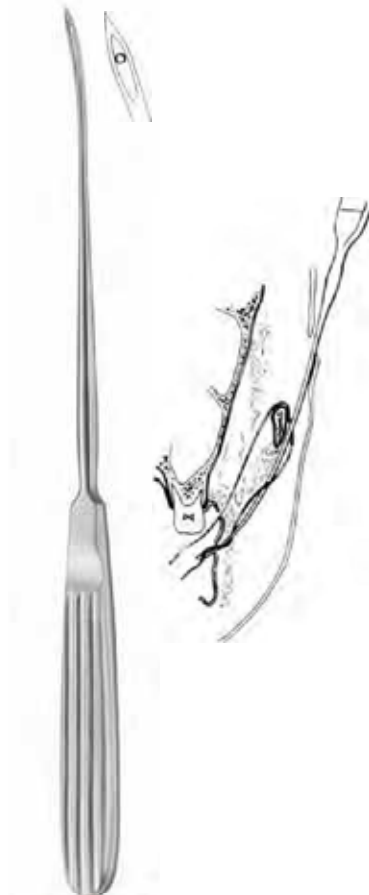

OBWEGESSER
48.679.24
24 cm/9½"

Fresa
para cortes verticales



Longitud de trabajo

10 mm	22 mm	35 mm
39.156.45	39.156.65	39.156.80
4,5 cm/1¾"	6,5 cm/2½"	8 cm/3¼"

LINDEMANN

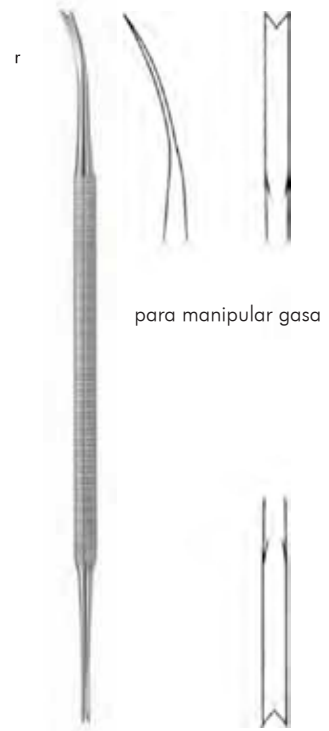

para manipular gasa

LUNIATSCHEK
50.151.19
19 cm/7½"

Sindesmotomo

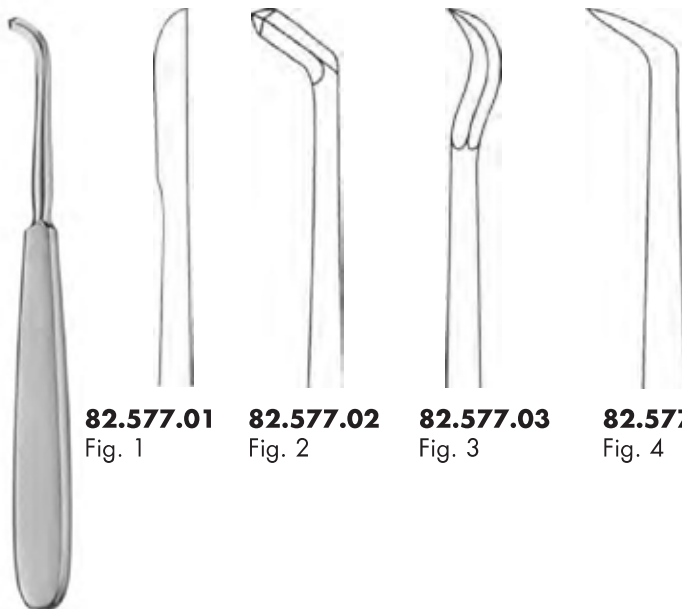

82.577.01
Fig. 1

82.577.02
Fig. 2

82.577.03
Fig. 3

82.577.04
Fig. 4

CHOMPRET
15 cm/6"



para posicionar
alambre

MERSHON
86.528.01
15 cm/6"



MAXILARIA

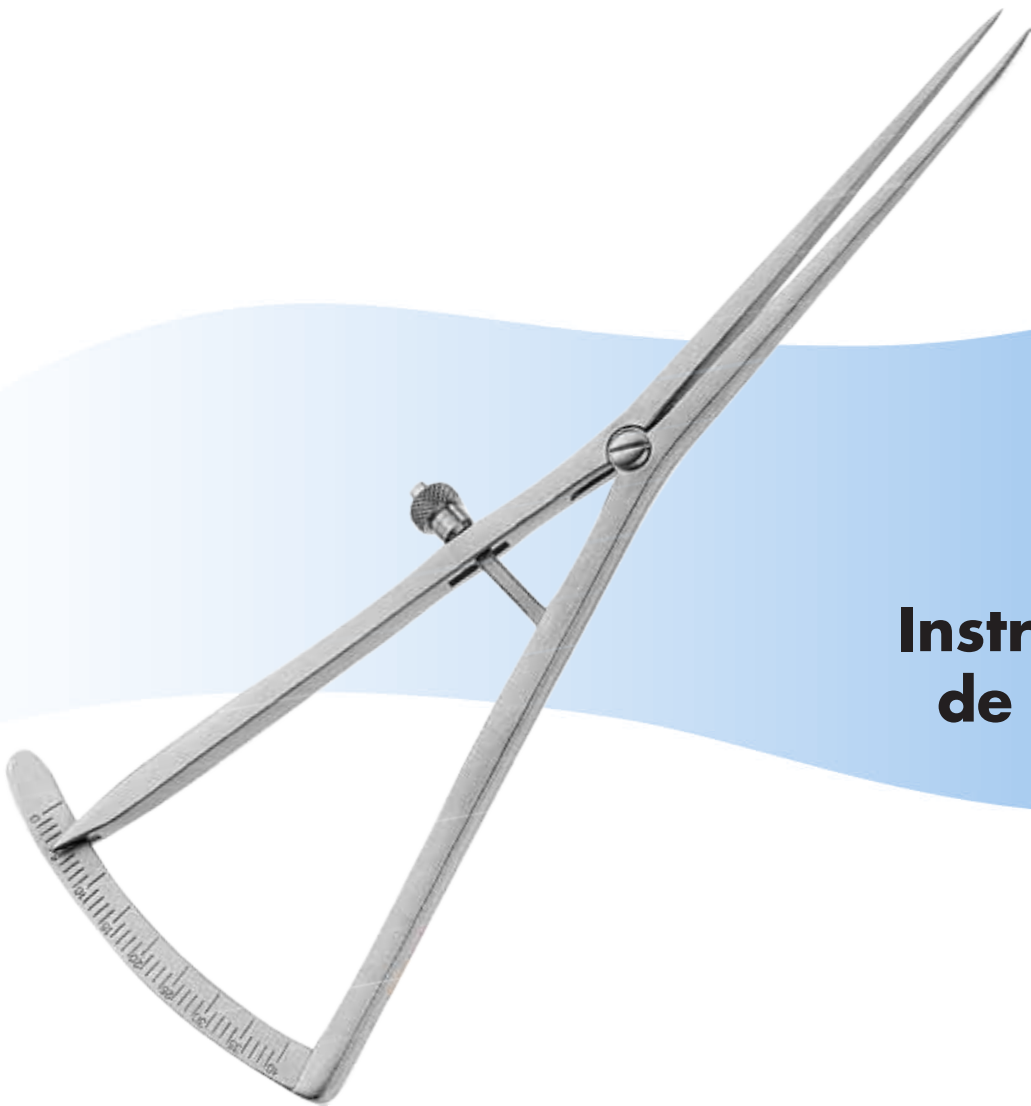

**Instrumental
de medida**

15 mm
rango de
medición



CASTROVIEJO
42.583.06

20 mm
rango de
medición



CASTROVIEJO
42.583.07

20 mm
rango de
medición



CASTROVIEJO
42.583.09

80 mm
rango de
medición



THORPE (MARCHAC)
42.581.80
12 cm/4³/₄"



40 mm
rango de
medición



CASTROVIEJO-EPKER
48.992.18
18 cm/7"

40 mm
rango de
medición



CASTROVIEJO-EPKER
48.992.09
9 cm/3¹/₂"

10 cm/4"	02.340.10
15 cm/6"	02.340.15
20 cm/8"	02.340.20
25 cm/20"	02.340.25



MAXILARIA



Tubos de succión

Tubos de succión

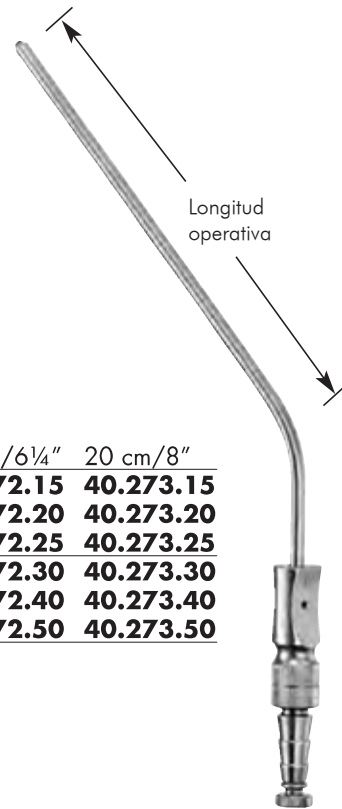

FERGUSON

Ø mm	F.G. Charr.	11 cm/4¼"	13 cm/5"	16 cm/6¼"	20 cm/8"
Ø 1,5 mm	4 - 5	40.270.15	40.271.15	40.272.15	40.273.15
Ø 2,0 mm	6	40.270.20	40.271.20	40.272.20	40.273.20
Ø 2,5 mm	7 - 8	40.270.25	40.271.25	40.272.25	40.273.25
Ø 3,0 mm	9	40.270.30	40.271.30	40.272.30	40.273.30
Ø 4,0 mm	12	40.270.40	40.271.40	40.272.40	40.273.40
Ø 5,0 mm	15	40.270.50	40.271.50	40.272.50	40.273.50



HOUSE

Tubo succión	Tubo irrigación	
Ø 1,8 mm	Ø 1,8 mm	44.103.01
Ø 2,0 mm	Ø 2,0 mm	44.103.02
Ø 3,0 mm	Ø 2,0 mm	44.103.03
Ø 4,5 mm	Ø 2,0 mm	44.103.04
Ø 0,9 mm	Ø 0,7 mm	44.103.11
Ø 1,2 mm	Ø 0,9 mm	44.103.12
Ø 1,5 mm	Ø 1,2 mm	44.103.13

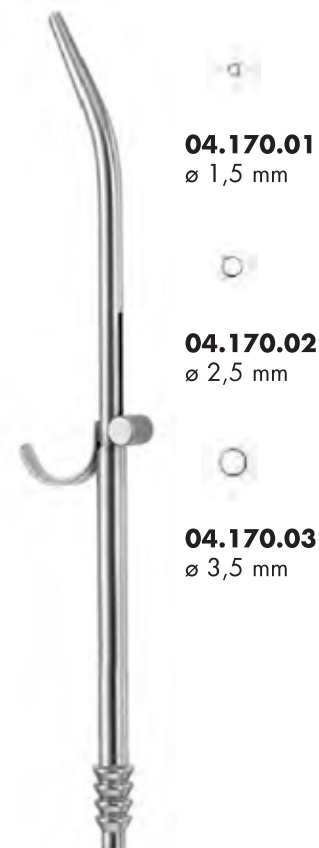

BYRD
21,5 cm/8½"

04.170.01
Ø 1,5 mm

04.170.02
Ø 2,5 mm

04.170.03
Ø 3,5 mm



MAXILARIA

Avda. Siglo XXI, 16 - Local 2, 28660 Boadilla del Monte (Madrid)

Tlf: 91 633 53 90 | Fax: 91 633 59 08

www.maxilaria.com | pedidos@maxilaria.com